

Mitel 6905 SIP Phone

RELEASE 6.1.0 USER GUIDE

58016544 REV00

October, 2021



Notice

The information contained in this document is believed to be accurate in all respects but is not warranted by **Mitel Networks™ Corporation (MITEL®)**. The information is subject to change without notice and should not be construed in any way as a commitment by Mitel or any of its affiliates or subsidiaries. Mitel and its affiliates and subsidiaries assume no responsibility for any errors or omissions in this document. Revisions of this document or new editions of it may be issued to incorporate such changes. No part of this document can be reproduced or transmitted in any form or by any means - electronic or mechanical - for any purpose without written permission from Mitel Networks Corporation.

Trademarks

The trademarks, service marks, logos and graphics (collectively "Trademarks") appearing on Mitel's Internet sites or in its publications are registered and unregistered trademarks of Mitel Networks Corporation (MNC) or its subsidiaries (collectively "Mitel") or others. Use of the Trademarks is prohibited without the express consent from Mitel. Please contact our legal department at legal@mitel.com for additional information. For a list of the worldwide Mitel Networks Corporation registered trademarks, please refer to the website: <http://www.mitel.com/trademarks>.

®, ™ Trademark of Mitel Networks Corporation
© Copyright 2021, Mitel Networks Corporation
All rights reserved

Software License Agreement

Mitel, hereinafter known as "Seller", grants to Customer a personal, worldwide, non-transferable, non-sublicenseable and non-exclusive, restricted use license to use Software in object form solely with the Equipment for which the Software was intended. This Product may integrate programs, licensed to Mitel by third party Suppliers, for distribution under the terms of this agreement. These programs are confidential and proprietary, and are protected as such by copyright law as unpublished works and by international treaties to the fullest extent under the applicable law of the jurisdiction of the Customer. In addition, these confidential and proprietary programs are works conforming to the requirements of Section 401 of title 17 of the United States Code. Customer shall not disclose to any third party such confidential and proprietary programs and information and shall not export licensed Software to any country except in accordance with United States Export laws and restrictions.

Customer agrees to not reverse engineer, decompile, disassemble or display Software furnished in object code form. Customer shall not modify, copy, reproduce, distribute, transcribe, translate or reduce to electronic medium or machine readable form or language, derive source code without the express written consent of the Seller and its Suppliers, or disseminate or otherwise disclose the Software to third parties. All Software furnished hereunder (whether or not part of firmware), including all copies thereof, are and shall remain the property of Seller and its Suppliers and are subject to the terms and conditions of this agreement. All rights reserved.

Customer's use of this software shall be deemed to reflect Customer's agreement to abide by the terms and conditions contained herein. Removal or modification of trademarks, copyright notices, logos, etc., or the use of Software on any Equipment other than that for which it is intended, or any other material breach of this Agreement, shall automatically terminate this license. If this Agreement is terminated for breach, Customer shall immediately discontinue use and destroy or return to Seller all licensed software and other confidential or proprietary information of Seller. In no event shall Seller or its suppliers or licensors be liable for any damages whatsoever (including without limitation, damages for loss of business profits, business interruption, loss of business information, other pecuniary loss, or consequential damages) arising out of the use of or inability to use the software, even if Seller has been advised of the possibility of such damages.

Contents

Welcome	1
6905 IP Phone	1
6905t IP Phone	1
About This Guide	1
Documentation	1
Phone Features	2
Requirements	2
Installation and Setup	2
IP Phone Keys	3
Key Panel	3
Key Description	4
Keypad Keys	5
E.164 support	7
Getting Started	8
Plugging in and Starting the Phone	8
Voice Services	10
Idle Screens	12
Incomplete Configuration	13
No Service	13
Methods for Customizing Your Phone	14
Phone Options through the IP Phone UI	14
Simplified Options List	16
Using the IP Phone UI	17
Phone Options through the Mitel Web UI	18
Using the Mitel Web UI	18
Phone Status	21
Phone Status through IP Phone UI	21

Finding Your Phone’s IP Address21
Phone Status through the Mitel Web UI22
SIP Account Status23
Customizing Your Phone	24
Ring Tones and Tone Sets24
Ring Tones24
Configuring Ring Tones and Tone Sets26
Installing Custom Ring Tones Using the Mitel Web UI28
Display29
Contrast Level29
Live Dialpad*29
Enabling/Disabling Live Dialpad29
Time and Date29
Configuring Time and Time Format30
Configuring Date and Date Format30
Configuring the Time Zone31
Configuring Daylight Savings Time31
Configuring Time Servers32
Language33
Specifying the Language to Use34
Input Language35
Latin 2 Character Set40
User Password41
CONFIGURING A USER PASSWORD41
Setting a User Password42
Resetting a User Password42
Restarting Your Phone43
Credentials44
Entering Usernames/Passwords and Connection Testing Using the IP Phone UI44
Directory45
Configuring Directory Display and Sorting Options Using the IP Phone UI 45	
Enabling/Disabling Directories and Renaming Labels Using the IP Phone UI 45	
Phone Lock46
Locking/Unlocking a Phone46
Emergency Dial Plan47
Defining an Emergency Dial Plan48
Line Key and Programmable Keys	49
Line and Call Appearance Keys49
Programmable Keys49
Creating a Speed Dial Key52

Speed Dial Prefix52
Press-and-Hold to Create a Speed Dial (applicable to programmable keys and keypad keys)52
Creating a Speed Dial Using the Speed Dial Edit Option53
Creating a Speed Dial Using a Programmable Key in the Mitel Web UI	54
Creating Speed Dial Key Using Keypad Speed Dial in the Mitel Web UI	55
Editing Speed Dial Keys55
Editing a Speed Dial on a Programmable Key56
Editing a Speed Dial Using Keypad Speed Dial in the Mitel Web UI	57
Do Not Disturb (DND) Key57
Configuring a DND Key58
XML Key58
Configuring an XML Key59
Accessing the XML Application59
Flash Key60
Configuring a Flash Key60
Sprecode Key60
Configuring a Sprecode Key61
Park/Pickup Keys61
Configuring Park/Pickup Keys62
Using the Park Call/Pickup Parked Call Feature62
Last Call Return Key63
Configuring a Last Call Return Key63
Call Forward Key63
Configuring a Call Forward64
Speeddial/Xfer64
Speeddial/Xfer Key Requirements and Functionality64
Configuring a Speeddial/Xfer Key65
Speeddial/Conf65
Configuring a Speeddial/Conf Key66
Directory Key66
Configuring a Directory Key66
Callers List Key67
Configuring a Callers List Key67
Redial Key68
Configuring a Redial Key68
Conference Key69
Configuring a Conference Key69
Transfer Key69
Configuring a Transfer Key70
Intercom Key70
Configuring an Intercom Key71
Using the Icom Key71
Services Key71
Configuring a Services Key72
Using the Services Key72

Phone Lock Key72
Configuring a Phone Lock Key73
Paging Key73
Configuring a Paging Key74
Using the Paging Key74
Save Key75
Configuring a Save Key75
Delete Key75
Configuring a Delete Key75
None Key76
Setting a None Key76
Discreet Ringing Key76
Configuring a Discreet Ringing Key76
Making Calls	78
Dialing a Number78
Using Handsfree Speakerphone78
USING A HEADSET79
MAKING AND RECEIVING CALLS USING A HEADSET79
Redial79
Accessing the Redial List80
Deleting An Item from the Redial List80
Delete All Items81
Mute81
Receiving Calls	82
Answering an Incoming Call82
Deflecting an Incoming Call82
Sending an Incoming Call to Voicemail83
Handling Calls	84
Placing a Call on Hold84
When on Hold84
Automatic Hold85
Retrieving a Held Call85
Transferring Calls85
Blind Transfer86
Consultative Transfer86
Direct Transfer86
Transferring Calls86
Transferring an Existing Call to Another Existing Call87
Completing a Transfer to a Contact in Phone Directory87
Indication of Transferred Calls88
Conferencing Calls88
Local Conferencing88

Centralized Conferencing (for Sylanro and BroadSoft Call Managers)	89
Ending a Conference and Transferring Remaining Parties91
Ending Calls91
Managing Calls	92
Directory92
General Directory Functions92
Local Directory Features93
Adding New Entries to the Local Directory94
Editing an Existing Local Directory Entry95
Deleting Entries in the Local Directory95
DELETE ALL ENTRIES IN THE LOCAL DIRECTORY96
Saving Entries to the Local Directory96
Downloading the Directory to Your PC96
External Directory Source Features97
Callers List98
Accessing the Callers List99
Editing Entries in the Callers List99
Deleting An Entry in the Callers List99
Deleting All Entries in the Callers List	100
Missed Calls Indicator	100
Downloading the Callers List to Your PC	100
DND and Call Forward	101
DND Configuration	101
Configuring a DND Key	102
Configuring DND Using the Mitel Web UI	103
Using DND Modes through the IP Phone UI	104
Call Forward Configuration	106
Configuring CFWD Using the Mitel Web UI	107
Using CFWD through the IP Phone UI	109
Additional Features119
Display DTMF Digits	119
CONFIGURING DISPLAY OF DTMF DIGITS	120
Play Call Waiting Tone	120
Configuring Call Waiting Tone	121
Stuttered Dial Tone	121
Configuring Stuttered Dial Tone	122
XML Beep Support	122
Configuring XML Beep Support	123
Status Scroll Delay	123
Configuring Status Scroll Delay	124
Switch UI Focus to Ringing Line	124
Configuring Switch Focus to Ringing Line Using the Mitel Web UI	125
Call Hold Reminder During Active Calls	125

Configuring Call Hold Reminder During Active Calls	126
Call Hold Reminder (on single hold)	126
Configuring Call Hold Reminder	127
Call Waiting Tone Period	127
Configuring Call Waiting Tone Period	128
Preferred Line and Preferred Line Timeout	128
Configuring Preferred Line and Preferred Line Timeout Using the Mitel Web UI	130
Goodbye Key Cancels Incoming Calls	130
Configuring Goodbye Key to Cancel Incoming Calls	131
Message Waiting Indicator	131
Configuring Message Waiting Indicator	132
Incoming Intercom Call Features	132
Auto-Answer/Play Warning Tone	133
Microphone Mute	133
Allow Barge In	133
Configuring Incoming Intercom Settings	133
Group RTP Paging	134
Configuring Group RTP Paging	134
Shared Call Appearance (SCA) Call Bridging	135
Star Codes	137
Other Features	137
Troubleshooting Solutions	138
Why is my display blank?	138
Why can't I get a dial tone?	138
Why doesn't my phone ring?	138
Why is the light not coming on with a new voicemail message?	138
Why is my handset not working?	138
How do I find the IP address of my phone?	138
Why does my phone display the no service message?	139
How do I change my user password?	139
Why does my phone display bad encrypted config?	139
How do I restart the IP phone?	139
How do I lock my phone?	139
Limited Warranty	140
Exclusions	140
Warranty Repair Services	140
AFTER WARRANTY SERVICE	141
Limited Warranty (Australia Only)	142
Repair Notice	142
Exclusions	142
Warranty Repair Services	143

After Warranty Service	143
Appendix A - Time Zone Codes	145

Welcome

6905 IP Phone

The Mitel 6905 IP Phone is the preferred phone for those who want basic communications functions packaged in a compact enterprise device. The 6905 features dual Ethernet ports, three programmable Personal Keys and a large 2.75" LCD display. The 6905's true HD handset and speakerphone provide remarkable wideband audio quality. The Mitel 6905 IP Phone delivers exceptional value for businesses of all sizes.

6905t IP Phone

This phone is built from plastics protected with BioCote® antimicrobial technology. The device features plastics with surfaces that are treated with a silver-based compound that when tested against certain viruses and bacteria is shown to inhibit their growth by up to 99.9 percent. The 6905t IP Phone has a redesigned handset that minimizes crevices and holes that might collect germs, dirt, and grime. The handset's smooth surfaces and hard-wired cord make for easy cleaning, facilitating a more hygienic device.

To differentiate between the 6905 IP Phone and 6905t IP Phone, the Mitel shield icon is added to the phone, and handset to indicate that the phone is built from plastics protected with the antimicrobial technology. The 6905t model can also be identified by navigating to the **Settings > Status > Phone Info > Model**.

NOTE:

- The 6905t IP Phone is tested against certain viruses, not including COVID-19.
- BioCote® antimicrobial additives are EPA (US) registered. BioCote® is the registered trademark of BioCote Limited. BioCote® technology does not protect users or others against disease causing microbes including COVID-19 and is not a substitute for good hygiene and/or cleaning practices.

About This Guide

This guide explains how to use your new 6905 phone. Not all features listed are available by default. Contact your System Administrator to find out which features and services are available on your system. Your System Administrator also has the ability to customize some features on this phone. For information on more advanced settings and configurations, administrators should refer to the **Mitel SIP IP Phones Administrator Guide**.

Documentation

- **Mitel 6905 SIP IP Phone Installation Guide**-Contains installation and set-up instructions, general features and functions, and a basic list of configuration options. The Installation Guide can be downloaded from <http://www.miteldocs.com>.

- **Mitel 6905 SIP IP Phone User Guide**– Describes the most commonly used features and functions for an end user. The User Guide can be downloaded from <http://www.miteldocs.com>.
- **Mitel SIP IP Phones Administrator Guide**– Describes how to set up the Mitel SIP IP phones on the network and contains advanced configuration instructions. The Administrator Guide is intended for the System Administrator and can be downloaded from <http://www.miteldocs.com>.

Phone Features

- 2.75" 128x48 Pixel non back-lit display
- Built-in two-port, 10/100 Megabit Fast Ethernet switch
- Class 1 Power-Over-Ethernet (PoE)
- Wide-band, full-duplex speakerphone for hands-free calls
- Wide-band 6900 handset
- 3 paper labeled personal programmable keys with LEDs
- Support for wall mounting using the 6800/6900 wall-mount kit
- Single call line support with LED
- Mitel Wireless LAN Adapter

Requirements

- Mitel communications platform with firmware release that supports 6900 phones.
- Access to a configuration server through Trivial File Transfer Protocol (TFTP) , File Transfer Protocol (FTP), or HTTP(s) server.
- Ethernet/Fast Ethernet LAN (10/100 Mbps) (Gigabit Ethernet LAN [1000 Mbps] recommended).
- Category 5/5e straight-through cabling (Category 6 straight-through cabling required for optimum Gigabit Ethernet performance).
- For Ethernet networks that supply inline power to the phone (IEEE 802.3af/ 802.3at) use an Ethernet cable to connect from the phone directly to the network for power (no 48V AC power adapter required if using Power-overEthernet [PoE]).
- For Ethernet networks that DO NOT supply inline power to the phone, use only the Mitel approved power adapter to connect from the DC power port on the phone to a power source, or use a PoE power injector or a PoE switch.

Installation and Setup

If your System Administrator has not already setup your 6905 SIP phone, please refer to the **Mitel 6905 Installation Guide** for basic installation and physical setup. For more advanced administration and configuration information, System Administrators should refer to the **Mitel SIP IP Phones Administrator Guide**.

IP Phone Keys

Key Panel

The following sections describe the various 6905 phone key functions and how they help you make and manage your calls and caller information. Images of the symbol keys and the symbol hardware platform are used throughout this document.

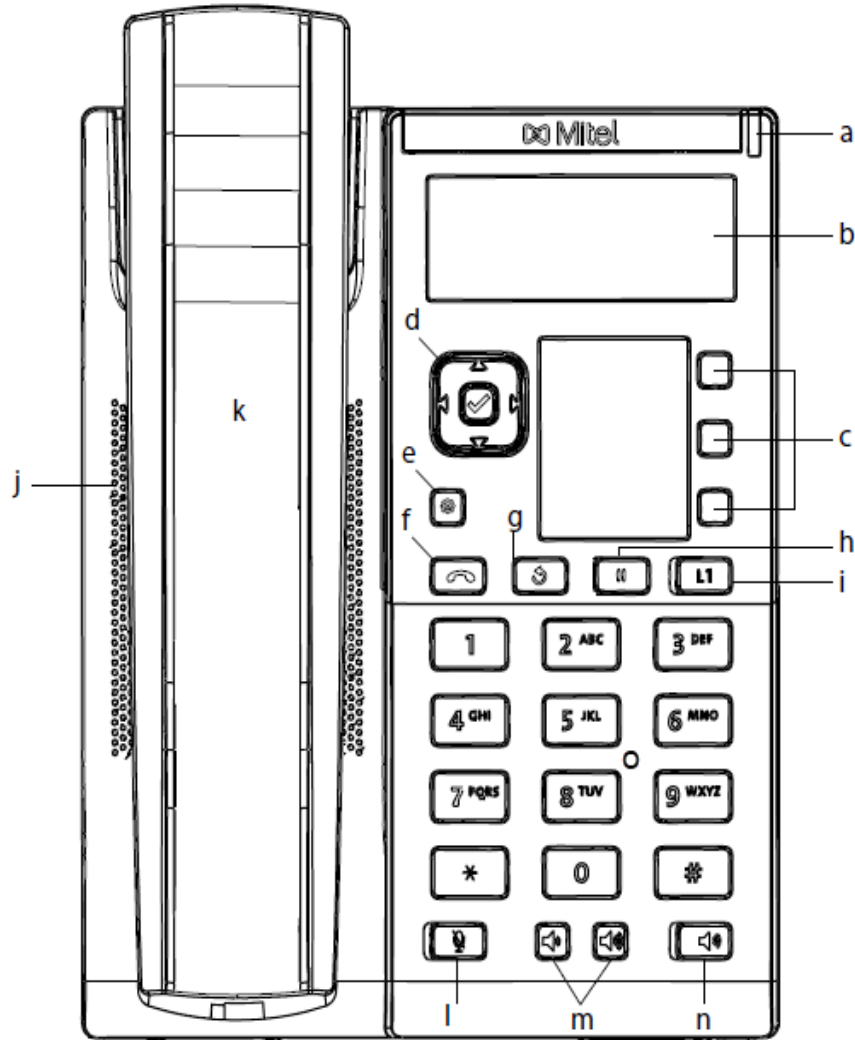











a	Message Waiting Lamp	b	LCD Screen
c	Programmable Keys	d	Navigation Keys
e	Options Key	f	Goodbye Key
g	Redial Key	h	Hold Key

i	Line Appearance Key	j	High Quality Speakerphone
k	6905 Handset	l	Mute Key
m	Volume Control	n	Speaker Key
o	Keypad		

Key Description

The following table identifies the keys on the key panel of your 6905 IP phone that you can use for handling calls.

KEY	DESCRIPTION
	<p>Navigation/Select Keys- Pressing the UP and DOWN keys lets you view different status and text messages on the LCD display (if there is more than 1 line of status/text messages). These buttons also let you scroll through menu selections, such as the Options List.</p> <p>Pressing the LEFT and RIGHT keys lets you view the different line/call appearances. While in the Options List, these keys allow you to exit or enter the current option. When you are editing entries on the display, pressing the LEFT key erases the character on the left; pressing the RIGHT key sets the option. Alternatively, pressing the center Select key sets the option as well on specific screens.</p>
	<p>Options Key- Accesses services and options to customize your phone. Your System Administrator may have already customized some of your settings. Check with your System Administrator before changing the administrator-only options. For more information, see “Phone Options through the IP Phone UI”.</p>
	<p>Goodbye Key- Ends an active call. The Goodbye key also exits an open list, such as the Options List, without saving changes.</p>
	<p>Redial key—Redials the last manually dialed number displayed on the LCD screen.</p>

KEY	DESCRIPTION
	Hold Key- Places an active call on hold. To retrieve a held call, press the line/call appearance button beside the light that is flashing. For more information, see “Placing a Call on Hold” .
	Line/Call Appearance Keys- Connects you to a line or call. The Mitel 6905 SIP phone supports one line key with an LED indicator light. For more information, see “Line and Call Appearance Keys” .
	Mute Key- Mutes the microphone so that your caller cannot hear you (the light indicator flashes when the microphone is on mute). For more information, see “Mute” .
	Volume Controls- Adjusts the volume for the handset, ringer, and handsfree speaker.
	Speaker Key- Transfers the active call to the speaker, allowing handsfree use of the phone. For more information, see “Using Handsfree Speakerphone” .
	Programmable Keys- When programmed, allows you to easily perform up to 3 specific functions (e.g. Services, Directory, Intercom, etc...) and access enhanced services provided by third parties (e.g. XML applications). The programmable keys are pre-configured as (from top to bottom) Callers, Directory, and Transfer keys. For more information, see “Programmable Keys” .

Keypad Keys

The 6905 has a keypad with digits from 0 through 9, a * key, and a # key. Keys 2 through 9 contain the letters of the alphabet. The 6905 phone keypad includes the following:

KEYPAD KEY	DESCRIPTION
0	Dials 0 Dials the Operator on a registered phone
1	Dials 1

KEYPAD KEY	DESCRIPTION
2 ABC	Dials 2 When entering text, this key enters A with one press, B with two presses, and C with three presses.
3 DEF	Dials 3 When entering text, this key enters D with one press, E with two presses, and F with three presses.
4 GHI	Dials 4 When entering text, this key enters G with one press, H with two presses, and I with three presses.
5 JKL	Dials 5 When entering text, this key enters J with one press, K with two presses, and L with three presses.
6 MNO	Dials 6 When entering text, this key enters M with one press, N with two presses, and O with three presses.
7 PQRS	Dials 7 When entering text, this key enters P with one press, Q with two presses, R with three presses, and S with four presses.
8 TUV	Dials 8 When entering text, this key enters T with one press, U with two presses, and V with three presses.
9 WXYZ	Dials 9 When entering text, this key enters W with one press, X with two presses, Y with three presses, and Z with four presses.

The * is called the star key. The # is called the number sign, pound key, or hash key, depending on one's nationality or personal preference. These can be used for special functions such as accessing voicemail. The star key and pound key functions are dependent on your country's feature availability. Contact your System Administrator for more information about available functions using these keys.

These keypad keys can be used for any of the following on the phone:

- Dialing a phone number to make a call (see ["Dialing a Number"](#)).
- Entering digits or letters in the IP phone user interface.
- Programming a speed dial number (see ["Creating a Speed Dial Key"](#)).
- Pressing a speed dial key (see ["Creating a Speed Dial Key"](#)).

- Pressing the keys associated with a called Interactive Voice Response (IVR) system.

E.164 support

E.164 is the international telephone numbering plan that ensures each device on the PSTN has a globally unique number. E.164 numbers are formatted as [+] [country code] [subscriber number including area code], and can have a maximum of 15 digits.

Users can dial E.164 numbers from 6905 phone. The support for inserting the '+' symbol is provided to users in the following ways:

- When dialing from the phone, users can insert the '+' symbol by a long-press of the '0' key.
- When entering an E.164 number as a number entry in the directory from the phone UI, users can insert the '+' symbol by a long-press of the '0' key.
- When entering an E.164 number as a number entry in the keypad Speed dial from the phone UI, users can insert the '+' symbol by a long-press of the '0' key.

Getting Started

The 6905 must be set up and configured prior to its first use. This section describes phone behavior and start up screens you may see when the phone is first plugged in, or when it is restarted.

Plugging in and Starting the Phone

The 6905 automatically begins the start up sequence as soon as it is connected. The phone goes through this process the first time you plug in your phone and every time you restart your phone.

NOTE: Some start up screens only appear the first time you connect your phone, or if your phone has been factory defaulted.

The phone displays the following startup screens:

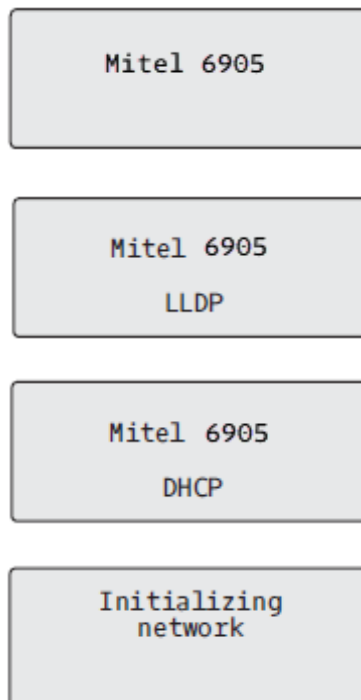

During the first start up, the 6905 phone attempts to contact the **Redirection and Configuration Server** for current server information. No personal information is transmitted from the phone during this process.

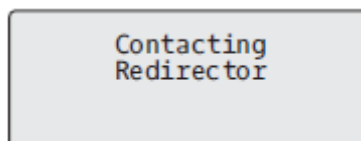

The 6905 phone may also look for configuration servers on your local network (press ► **Skip** to continue without checking for servers).

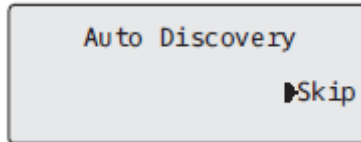

If appropriate servers are found they are listed for you to select from by scrolling down to view the complete list. (Press **▲ Skip** to continue without selecting a server.).

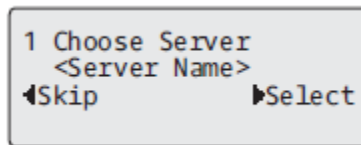

The 6905 phone then checks settings and looks for new configuration and firmware updates from a server. If a new update is found, the phone displays the message **Updating Configuration**. This may take a few moments while the phone downloads the latest updates.

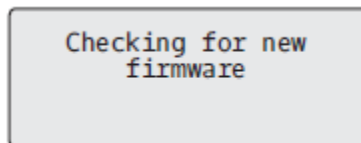
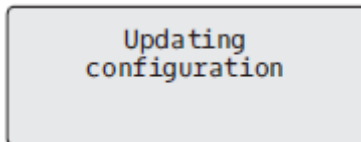

NOTE: New updates to your phone can be automatically scheduled from the server. This is set up on the phone system by your System Administrator and should be scheduled during non-business hours or slow call periods.

WARNING: Do not unplug or remove power to the phone while it is checking or installing firmware and configuration information.

If language packs were loaded to your phone by your System Administrator, the following screen displays during startup.

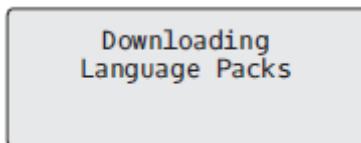

When the configuration update is complete, the phone displays the following screens:

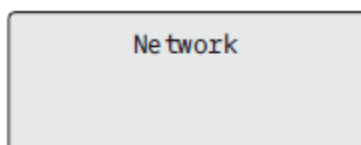

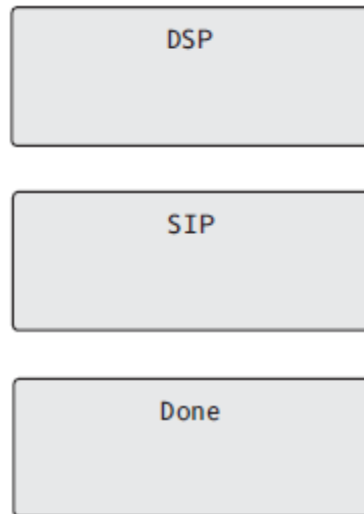

Voice Services

Voice Services can be configured on Mitel 6905 SIP phones to provide remote workers access to the same rich communication capabilities as provided to in-office workers.

After the initial boot-up of the SIP phone, a **Voice Services** screen auto-prompts the user to select an appropriate service.

NOTE: After a factory default, if the phone is configured through Web UI reboot message is displayed on the Web UI and the phone reboots in the configured environment.

The user can select from one of the following service options:

- **MiCloud Connect**
- **MiVoice Connect**
- **Manual Configuration**
- **Manual Software Upgrade**

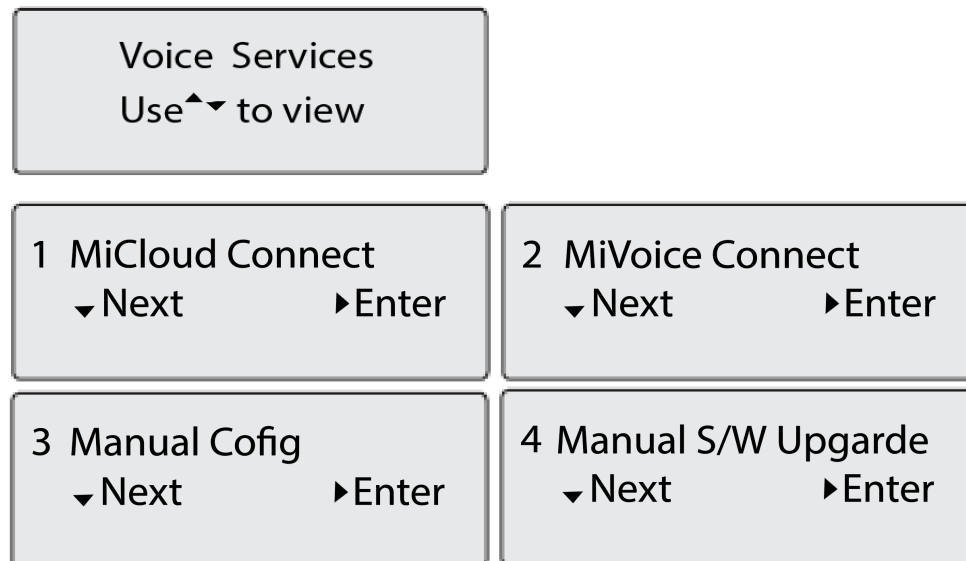

- For MiCloud Connect, enter **User DID** and **Password**.

1 User DID ▼Next ►Enter	2 Password: ▼Next ►Enter
---------------------------------	----------------------------------

- For MiVoice Connect in the **Config. Server** field, enter the MiVoice Connect Server IP address.

1 Config Server 1 ▼Next ►Enter	2 Config Server 2 ▼Next ►Enter
--	--

Or, edit the existing MiVoice Connect Configuration Server address.

- For Manual Configuration, enter information in the following fields:
 - In the **Download Protocol** field, select the protocol for downloading firmware from the server.
 - In the **Primary Server** field, enter the domain name or the IP address of the server.
 - In the **Primary TFTP Path** field, enter the name of the folders where the firmware you want to install must be stored.

1 Download Protocol ▼Next ►Enter
--

1 Primary Server ▼Next ►Enter	2 Pri TFTP Path ▼Next ►Enter
---------------------------------------	--------------------------------------

- For Manual Software Upgrade, enter information in the following fields:
 - In the **Download Protocol** field, select the protocol for downloading firmware from the server
 - In the **Server** field, enter the domain name or the IP address of the server.
 - In the **Port** field, enter the server port number that is used for downloading firmware.
 - In the **Path** field, enter the name of the folders where the firmware you want to install must be stored.

1 Download Protocol ▼Next ▶Enter	1 Primary Server ▼Next ▶Enter
3 TFTP Port ▼Next ▶Enter	2 Pri TFTP Path ▼Next ▶Enter

NOTE:

- The phone will auto reboot after configuring the Voice Services at the initial bootup on the TUI.
- The phone will auto reboot if the user enters the configuration server details and/or configure a line on the WebUI.

To view or edit the Voice Services settings on the Mitel 6905 SIP phone:

1. Press the  (**Options**) key on the phone to enter the **Options** menu.
2. Navigate to **Voice Services** using the navigation keys and press the **Select** softkey.
3. Use the up and down navigation keys to choose either of the following and then press the **Next** softkey.
 - MiCloud Connect
 - MiVoice Connect
4. Make the required changes.
5. Press the **Save/Register** softkey to save your changes.

Idle Screens

When the phone has successfully updated the configuration and connected to the network, the phone displays the **Idle State** screen:

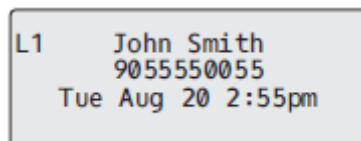

The **Idle State** screen lists your name (SIP screen name), extension (or phone number), and the date and time. This screen is shown whenever your phone is not in use. The L1 in the upper corner in the above example indicates the idle screen for the first line appearance. You can use the left and right arrow keys to scroll through the idle screens for both line appearances on the 6905.

The second display line shows the following temporary messages if the event occurs:

- No Service

- DHCP Failed
- Restarting
- New IP Obtained
- Network Disconnected/Connected
 - NOTE:** Since Network Disconnected/Connected displays on two lines, the date and time does not show if this event displays.
- The second line can also display the following status messages, listed in order of display priority:
- Call Forward status
- DND (Do Not Disturb) On
- Number of missed calls

When more than one status message displays, the ▲ is shown after the message to indicate that you can use the ▲ and ▼ navigation keys to scroll through the remaining messages.

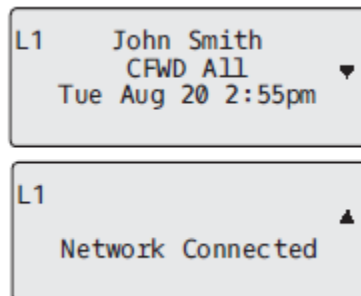

Incomplete Configuration

If your phone displays an **Incomplete Config** message without any extension or user name at the end of the start up sequence instead of an Idle state screen, this indicates the phone configuration that was downloaded from the configuration server is not complete or correct. Contact your System Administrator for assistance.

No Service

When the phone is not properly connected to the network, or the account has not been configured by the Network Administrator, the **No Service** or **Network Disconnected** prompt appears on the display and the telephone status light turns ON. Check that the cables are tightly connected to the phone and to the wall jack. The phone should automatically detect when the connection is reconnected and display the **Network Connected** prompt temporarily.

If changes have been made to your phone settings, you may need to restart your phone. For more information on restarting your phone, see [“Restarting Your Phone”](#).

For more information about connecting your phone, refer to the **Mitel 6905 Installation Guide** or check with your System Administrator for assistance.

Methods for Customizing Your Phone

There are two ways to customize specific options on your phone:

- Using the **Options**  key on the IP phone.
- Using the Mitel Web UI in an Internet browser window from your PC.

Phone Options through the IP Phone UI

You can customize your phone by pressing the  key and accessing the IP phone UI. These options allow you to customize the following phone settings.

Option Number	OPTION
1	Services <ol style="list-style-type: none"> 1. Conference 2. Transfer 3. Redial 4. Directory 5. Callers List 6. Voicemail 7. Do Not Disturb
2	Call Forward <ol style="list-style-type: none"> 1. All 2. Busy 3. No Answer 4. All Off 5. All On <p>The menus that display for Call Forward are dependent on the Call Forward Mode set on the phone. Default is Account mode.</p>

Option Number	OPTION
3	Preferences <ol style="list-style-type: none"> 1. Tones <ul style="list-style-type: none"> - Ring Tone - Tone Set 2. Display <ul style="list-style-type: none"> - Contrast Level 3. Speed Dial Edit 4. Live Dialpad 5. Time and Date <ul style="list-style-type: none"> - Time Format - Daylight Savings - Date Format - Time Zone - Time Server 1 - Time Server 2 - Time Server 3 - Set Time - Set Date 6. Language <ul style="list-style-type: none"> - Screen Language - Input Language
4	Phone Status <ol style="list-style-type: none"> 1. IP&MAC Addresses 2. LAN Port 3. PC Port 4. Firmware Info 5. Error Messages 6. Copyright
5	Password
6	Admin Menu (Password Protected)*
7	Restart Phone
8	Credentials (available only if certain features are configured by your Administrator)

Option Number	OPTION
9	Directory <ol style="list-style-type: none"> 1. Display Name Order 2. Sorting Preferences 3. External Sources (available only if external directory sources are configured by your Administrator)
10	Phone Lock
11	Diagnostics
12	Log Issue

NOTE: The **Administrator Menu** options are Administrator-level functions only, and are not accessible by the user. These options should only be set up and changed by your System Administrator.











Simplified Options List

Your System Administrator may configure a simplified Options List for your phone. The following table indicates the options that may appear on your phone if the simplified Options List is applied:

OPTION NUMBER	OPTION
1	Services <ol style="list-style-type: none"> 1. Conference 2. Transfer 3. Redial 4. Directory 5. Callers List 6. Voicemail 7. Do Not Disturb
2	Call Forward <ol style="list-style-type: none"> 1. All 2. Busy 3. No Ans 4. All Off 5. All On <p>The menus that display for Call Forward are dependent on the Call Forward Mode set on the phone. Default is Account mode.</p>

OPTION NUMBER	OPTION
3	Preferences <ol style="list-style-type: none"> 1. Tones <ul style="list-style-type: none"> – Ring Tone – Tone Set 2. Display <ul style="list-style-type: none"> – Contrast Level
4	Phone Status <ol style="list-style-type: none"> 1. IP&MAC Addresses 2. LAN Port 3. PC Port 4. Firmware Info 5. Error Messages 6. Restart Phone 7. Copyright
5	Phone Lock
6	Diagnostics
7	Log Issue

Using the IP Phone UI

1. Press the  key on the phone to enter the Options List.
2. Press the  and  keys to view the different options.
3. Press the  key, the  **Enter** key, or press the number of the corresponding option to select an option.
4. Change the selected option if required.
5. Press the  key or the  **Set**, or  **Done** key to save the change.
6. Press the  key, the  navigation key, or the  key at any time to exit without saving changes.

NOTE: For more information about customizing your phone using the available options from the IP phone UI, see the section [Customizing Your Phone](#) . For more information about Administrator options, contact your System Administrator.

Phone Options through the Mitel Web UI

In addition to the IP phone UI options, you can customize additional options on the IP phone using the Mitel Web UI. In order to access your phone using the Mitel Web UI, you need to know your phone's IP address. To find your phone's IP address, see [Finding Your Phone's IP Address](#) .

Using the Mitel Web UI

Mitel Web UI

1. Open your web browser, enter the phone's IP address or host name into the address field and press **Enter**.

The following logon screen displays:



2. At the prompt, enter your username and password and click **OK** .

The Status window displays for the IP phone you are accessing.

NOTE: For a user, the default username is **user** and the password field is left blank.

Mitel 6905 Log Off

Status
System Information

Operation
User Password
Phone Lock
Programmable Keys
Keypad Speed Dial
Directory
Reset

Basic Settings
Preferences
Account Configuration
Custom Ringtones

System Information

Network Status

Attribute	LAN Port	PC Port
Link State	Up	Down
Negotiation	Auto	Auto
Speed	100Mbps	10Mbps
Duplex	Full	Half

Hardware Information

Attribute	Value
MAC Address	00:08:5D:77:67:D0
Platform	6905 Rev. 000

Firmware Information

Attribute	Value
Firmware Version	6.1.0.99
Firmware Release Code	SIP
Date/Time	Aug 18 2021 04:41:41
Boot Version	Boot2 1.0.0.J Apr 7 2020 05:42

SIP Status

Line	SIP Account	Status	Backup Registrar Used?
1	67264@0.0.0.0	Unregistered	Yes

3. You can logout of the Mitel Web UI at any time by clicking **Log Off**.

The following categories display in the side menu of the Mitel Web UI: **Status**, **Operation**, and **Basic Settings** .

HEADINGS	DESCRIPTIONS
Status	The Status - section displays the network status and the MAC address of the IP phone. It also displays hardware and firmware information regarding the IP phone, and information about the SIP account(s) currently configured on the phone. The information in the Status window is read-only.
Operation	<p>User Password - Allows you to change the user password.</p> <p>Phone Lock - Allows you to assign an emergency dial plan to the phone, lock the phone to prevent any changes to the phone and to prevent use of the phone, as well as reset the user password.</p> <p>Programmable Keys - Allows you to configure up to 3 programmable keys with functions identified. Available functions for programmable keys are listed in the table Softkey list provided in Programmable Keys topic.</p> <p>Keypad Speed Dial - Allows you to assign a speed dial number to a specific digit on the phone’s keypad/dialpad for speed dialing purposes.</p> <p>Directory - Allows you to copy the Callers List and Local Directory from your IP phone to your PC.</p> <p>Reset - Allows you to restart the IP phone when required.</p>

HEADINGS	DESCRIPTIONS
Basic Settings	<p>Preferences- Allows you to enable/disable the following:</p> <ul style="list-style-type: none"> • Display DTMF Digits • Play Call Waiting ToneStuttered Dial Tone • XML Beep Support • Status Scroll Delay (seconds) • Switch UI Focus to Ringing Line • Call Hold Reminder During Active Calls • Call Hold Reminder • Call Waiting Tone Period • Preferred line • Preferred line Timeout (seconds) • Goodbye Key Cancels Incoming Call • Message Waiting Indicator Line • DND Key Mode • Call Forward Key Mode <p>This category also allows you to configure:</p> <ul style="list-style-type: none"> • Incoming Intercom Call Settings • Group Paging RTP Settings • Ring Tones (global and per-line basis) • Time and Date Settings • Language Settings <p>Account Configuration - Allows you to configure DND and Call Forward by account. You can have multiple accounts on the 6905.</p> <p>Custom Ringtones - Allows you to upload up to 8 custom WAV file ringtones on the phone that can be used as your incoming ring tone. For more information on custom ringtones, see Installing Custom Ring Tones Using the Mitel Web UI.</p>

Phone Status

You can view the status of your phone using the IP phone UI or the Mitel Web UI.

Phone Status through IP Phone UI



The **Phone Status** option on the IP phone displays the status of your phone to the LCD display.

This option allows you to view your phone's:

- Network status including your phone's IP and MAC addresses
- Local Area Network (LAN) port information
- PC Port information (if PC link exists)
- Firmware information
- Error messages from the last reboot or startup
- Copyright information

IP Phone UI



1. Press  on the phone to enter the Options List.
2. Select **Phone Status**.
3. Select the option you want to view:
 - IP&MAC Address
 - LAN Port
 - PC Port
 - Firmware Info
 - Error Messages
 - Copyright

The option you select displays to the screen. Use the  and  keys to scroll through the content displayed on screen.

Finding Your Phone's IP Address

If you want to access your phone's options using an Internet browser, you need to enter the IP address of the phone in the browser to open the Mitel Web UI. Use the following procedure to find your phone's IP address.

IP Phone UI

1. Press the  key on the phone to enter the Option List.
2. Select **Phone Status** and press the  key or  **Enter** key.

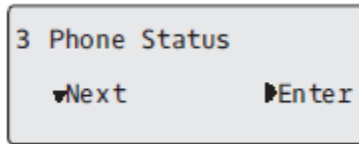

3. Select **IP&MAC Addresses** and press the key or **Enter** key.

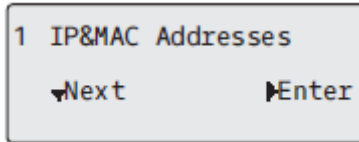

The IP address of your 6905 IP phone displays in the **IP Address** field.

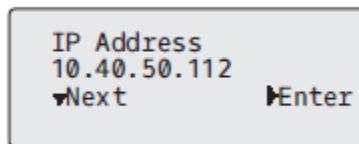

Phone Status through the Mitel Web UI

Use the following procedure to view the phone status through the Mitel Web UI .

1. Open your web browser, enter the phone’s IP address or host name into the address field and press **Enter**.
2. In the Username/Password window, enter your username and password and click **OK** . The **Status** window displays for the IP phone you are accessing.

NOTE: The default username is **user** and the password field is left blank.

Mitel
6905
Log Off

Status

System Information

Operation

User Password

Phone Lock

Programmable Keys

Keypad Speed Dial

Directory

Reset

Basic Settings

Preferences

Account Configuration

Custom Ringtones

System Information

Network Status

Attribute	LAN Port	PC Port
Link State	Up	Down
Negotiation	Auto	Auto
Speed	100Mbps	10Mbps
Duplex	Full	Half

Hardware Information

Attribute	Value
MAC Address:	00:08:5D:77:67:D0
Platform	6905 Rev. 000

Firmware Information

Attribute	Value
Firmware Version	6.1.0.99
Firmware Release Code	SIP
Date/Time	Aug 18 2021 04:41:41
Boot Version	Boot2 1.0.0.J Apr 7 2020 05:42

SIP Status

Line	SIP Account	Status	Backup Registrar Used?
1	67264@0.0.0.0	Unregistered	Yes

This **Status** window displays the status of your phone, which includes the following information:

- Network Status

- Hardware Information
- Firmware Information
- SIP Status

SIP Account Status

The IP phones show the SIP registration status on the IP phone's **Status** screen in the Mitel Web UI.

SIP Status			
Line	SIP Account	Status	Backup Registrar Used?
1	650@proxy.com:5060	Registered	Yes
2	651@proxy.com:5060	401	No

The following table describes the status conditions that can display for the account.

STATUS CONDITION	DESCRIPTION
Registered	<p>Displays this status on accounts that HAVE been registered with the SIPproxy server.</p> <p>Example: Line > SIP Account > Status > Backup Registrar Used? 1 > 650@proxy.com:5060 > Registered > Yes</p> <p>where:</p> <ul style="list-style-type: none"> • Account Number is 1 • SIP Account is 650@proxy.com on port 5060 • Status is Registered • Backup registrar is used (Yes)
SIP Error Number	<p>Displays on accounts when registration fails with the SIP proxy server.</p> <p>Example: Line > SIP Account > Status > Backup Registrar Used? 2 > 651@proxy.com:5060 > 401 > No</p> <p>where:</p> <ul style="list-style-type: none"> • Account Number is 4 • SIP Account is 651@proxy.com on port 5060 • Status is 401 - Unregistered if SIP registration fails • Backup registrar is used (No)

Customizing Your Phone

The following paragraphs describe the options available from either the IP phone UI, the Mitel Web UI, or both, and provide procedures applicable to the option.

Ring Tones and Tone Sets

You can configure ring tones and ring tone sets on the IP phone.

Ring Tones

There are several distinct ring tones a user can select to set on the IP phones. In addition to the 15 pre-installed ringtones, custom ring tones can be manually installed through the Web UI and selected for use (if enabled by your Administrator). You can enable/disable these ring tones on a global or per-line basis.

There are 10 additional ringtones available (Velocity, Skyline, Rise, Daybreak, After Hours, Open Road, Pronto, Voyage, Bloom, Move).

NOTE: Individual contact ring tones are also supported on the 6905. Individual contact ring tones can be used during incoming calls to help users identify the party calling. For more information on individual contact ring tones, see [Local Directory Features](#).

The following table identifies the valid settings and default values for each type of configuration method:

Ring Tones

CONFIGURATION METHOD	VALID VALUES	DEFAULT VALUE
IP Phone UI	Global Velocity Skyline Rise Daybreak After Hours Open Road Pronto Voyage Bloom Move Tone 1 to 15 Silent Custom Ring Tone 1 to 8 (if available)	Global Setting: Tone 1

CONFIGURATION METHOD	VALID VALUES	DEFAULT VALUE
Mitel Web UI	Global: Velocity Skyline Rise Daybreak After Hours Open Road Pronto Voyage Bloom Move Tone 1 to 15 Silent Custom Ring Tone 1 to 8 (if available)	Global Setting: Tone 1
Lines 1 to 2	Per-Line Setting: Global Velocity Skyline Rise Daybreak After Hours Open Road Pronto Voyage Bloom Move Tone 1 to 15 Silent Custom Ring Tone 1 to 8 (if available)	Per-Line Setting: Global

Ring Tone Sets

In addition to ring tones, you can configure ring tone sets on a global-basis on the IP phone. Ring tone sets consist of tones customized for a specific country. The ring tone sets you can configure on the IP phones are:

- Australia
- Brazil
- Canada
- Europe (generic tones)
- France
- Germany
- Italy
- Italy2
- Malaysia

- Mexico
- Russia
- Slovakia
- UK
- US (Default)

When you configure the country's tone set, the country-specific tone is heard on the phone for the following:



- Dial tone
- Secondary dial tone
- Ring tone
- Busy tone
- Congestion tones
- Call waiting tone
- Ring cadence pattern

You configure global ring tones and tone sets using the IP phone UI and Mitel Web UI. Installing a custom ring tone can be performed using the Mitel Web UI only.

Configuring Ring Tones and Tone Sets

IP Phone UI

Global configuration only

1. Press  on the phone to enter the Options List.
2. Select **Preferences**.
3. Select **Tones**.
4. Select **Ring Tone**.
5. Select the type of ring tone (**Velocity**, **Skyline**, **Rise**, **Daybreak**, **After Hours**, **Open Road**, **Pronto**, **Voyage**, **Bloom**, **Move**, **Tone 1** through **Tone 15** , **Silent**, or any custom ring tones installed).
6. Press the  key or select  **Set**.
7. Select **Tone Set**.
8. Select the country for which you want to apply the tone set. Valid values are:
 - Australia
 - Brazil
 - Canada
 - Europe
 - France
 - Germany
 - Italy
 - Italy2
 - Malaysia

- Mexico
- Russia
- Slovakia
- UK
- US (default)

9. Press the  key or select  **Set**.

10. The ring tone and tone set you select is immediately applied to the IP phone.

Mitel Web UI

1. Click on **Basic Settings > Preferences > Ring Tones**.

Ring Tones	
Tone Set	US ▼
Global Ring Tone	Tone 1 ▼
Line 1	Global ▼
Line 2	Global ▼

For global configuration

2. In the **Ring Tones** section, select a country from the **Tone Set** field. Valid values are:

- Australia
- Brazil
- Canada
- Europe
- France
- Germany
- Italy
- Italy2
- Malaysia
- Mexico
- Russia
- Slovakia
- UK
- US (default)

3. Select a value from the **Global Ring Tone** field.

NOTE: See the [Ring Tones](#) for valid values.

For per-line configuration

4. In the **Ring Tone** section, select a line for which you want to set ring tone.

5. Select a value from the **LineN** field.

NOTE: See the [Ring Tones](#) for valid values.

6. Click **Save Settings** .

Installing Custom Ring Tones Using the Mitel Web UI

NOTE:

1. Access to the Custom Ringtones Web UI menu is only available if enabled by your System Administrator.
2. Ringtones must be in .wav format. The IP phones support the following WAV file specifications:
 - G.711 μ -law and a-law Codec
 - 20 ms packet size
 - Mono 8KHz
3. Individual WAV files cannot exceed 1 MB in size (the total combined size of the eight WAV files cannot exceed 8 MB).
4. Filenames must contain only ASCII characters.

Mitel Web UI

1. Click on **Basic Settings > Custom Ringtones**.



2. Press the **Browse...** button corresponding to the desired ringtone position (e.g. 1).
3. Navigate to the folder containing the WAV file you want to upload, select the file using your left mouse button, and press the **Open** button. The filename should now be displayed to the right of the respective **Browse...** button.
4. Press the **Upload** button to upload the file to the phone.
5. Repeat Steps 2 to 4 to upload additional WAV files to the phone.





NOTE: Press the **Delete** button to delete the desired ringtone from your phone.

Display

Contrast Level

The **Contrast Level** option on the IP phone allows you to set the amount of contrast on the LCD display. You can set the contrast level using the IP phone UI only.

Setting the Contrast Level IP Phone UI

1. Press  on the phone to enter the Options List.
2. Select **Preferences** .
3. Select **Display**.
4. Select **Contrast Level**.
5. Use the  and  navigation keys to increase or decrease the amount of contrast on the screen.
6. Press the  key or  **Select** to save your selection.

Live Dialpad*





The **Live Dialpad** option on the IP phone turns the live dialpad mode on or off. With the live dialpad feature enabled, the 6905 IP phone automatically dials out and turns on handsfree mode as soon as a dialpad/keypad key or programmable key is pressed. With live dialpad disabled, if you dial a number while the phone is on-hook, lifting the receiver or pressing the  initiates a call to that number.

NOTE: Availability of this feature is dependent on your phone system or service provider.

You can enable/disable the live dialpad using the IP phone UI only.

Enabling/Disabling Live Dialpad

IP Phone UI

1. Press  on the phone to enter the Options List.
2. Select **Preferences**.
3. Select **Live Dialpad**.
4. Use the  and  navigation keys to navigate to ON or OFF.
5. Press the  key or select  **Set** to save your selection.

Time and Date

On the IP phones, you can configure the following:





- Time and date

- Time and date format
- Time zone
- Daylight savings time
- Time servers

NOTE: Only the time and date formats and time servers can be set using the Mitel Web UI.



Configuring Time and Time Format

IP Phone UI

1. Press  on the phone to enter the Options List.
2. Select **Preferences**.
3. Select **Time and Date**.
4. Select **Set Time**.
5. Using the keys on the keypad, enter a time to set on the IP phone. Use the * key to set either AM or PM.
6. Press the  key or select **Done** to save the time setting.
7. Select **Time Format**.
8. Using the  and  navigation keys, set the Time Format to either a 12 hour format or a 24 hour format. Default is **12 Hour**.
9. Press the  key or select **Set** to save the Time Format you selected.

Configuring Date and Date Format

IP Phone UI

1. Press  on the phone to enter the Options List.
2. Select **Preferences**.
3. Select **Time and Date**.
4. Select **Set Date**.
5. Using the keys on the keypad, enter a date to set on the IP phone.
6. Press the  key or select **Done** to save the date setting.
7. Select **Date Format**.
8. Select a date format from the list of options. Valid values are:
 - WWW MMM DD (default)
 - DD-MMM-YY
 - YYYY-MM-DD
 - DD/MM/YYYY

- DD/MM/YY
- DD-MM-YY
- MM/DD/YY
- MMM DD
- DD MMM YYYY
- WWW DD MMM
- DD MMM
- DD.MM.YYYY

9. Press the  key or select  **Set** to save the Date Format setting.

Configuring the Time Zone

IP Phone UI



1. Press  on the phone to enter the Options List.
2. Select **Preferences**.
3. Select **Time and Date**.
4. Select **Time Zone** A list of Time Zones display for different areas of the world.
5. Select a Time Zone that applies to your area by using the navigation keys.
6. The default Time Zone is **US-Eastern**.

NOTE: For a list of the Time Zone values available on the IP phone, see [“Appendix A - Time Zone Codes.”](#)

7. Press the  key or select  **Set** to save the Time Zone setting.

Configuring Daylight Savings Time

IP Phone UI

1. Press  on the phone to enter the Options List.
2. Select **Preferences**.
3. Select **Time and Date**.
4. Select **Daylight Savings**.
5. Select a Daylight Savings time from the list of options. Valid values are:
 - OFF
 - 30 min summertime
 - 1 h summertime
 - **Automatic**(Default)
6. Press the  key or select  **Set** to save the Daylight Savings setting.

Configuring Time Servers

With a valid time server enabled your IP phone will synchronize the time displayed with the specified configuration server. The phone will use the time from Time Server 1 unless it is not configured or unavailable, in which case it will move on to Time Server 2, and if necessary Time Server 3.

IP Phone UI

1. Press  on the phone to enter the Options List.
2. Select **Preferences**.
3. Select **Time and Date**.
4. Select from **Time Server 1**, **Time Server 2**, or **Time Server 3**.
5. Enter an IP address or domain name for the time server.

NOTE: Time Servers are enabled by default. The Time Servers can be Enabled or Disabled only from the Mitel Web UI.

6. Press the key or select  **Set** to save the time server setting.

Mitel Web UI

1. Click on **Basic Settings > Preferences > Time and Date Setting**.



Time and Date Setting	
Time Format	12h
Date Format	WWW MMM DD
NTP Time Servers	<input checked="" type="checkbox"/> Enabled
Time Server 1	0.0.0.0
Time Server 2	0.0.0.0
Time Server 3	0.0.0.0

2. In the **Time Format** field, select the time format you want to use on your phone. Valid values are:

- **12h**(12 hour format) (default)
- **24h** (24 hour format)

NOTE: The time and time format you configure display on the phone's idle screen.

3. In the **Date Format** field, select the date format you want to use on your phone. Valid values are:

- WWW MMM DD (default)
- DD-MMM-YY
- YYYY-MM-DD
- DD/MM/YYYY
- DD/MM/YY
- DD-MM-YY
- MM/DD/YY
- MMM DD

- DD MMM YYYY
- WWW DD MMM
- DD MMM
- DD.MM.YYYY

NOTE: The date and date format you configure display on the phone's idle screen.

4. In the **NTP Time Servers** field, enable by checking the checkbox or disable by unchecking the box (default is enabled).
5. In the **Time Server 1**, **Time Server 2**, and **Time Server 3** fields, enter IP addresses or qualified domain names for the primary, secondary, and tertiary time servers.

NOTE: Time Servers can only be entered if NTP Time Servers is enabled.

6. Click **Save Settings**.

Language

The IP phones support several different languages. You can have the IP phone UI and the Mitel Web UI display in a specific language as required. When you set the language to use, all of the display screens (menus, services, options, configuration parameters, etc.) display in that language. The IP phones support the following languages:

- English
- Czech
- Catalan
- Valencian
- Welsh
- German
- Danish
- Spanish
- Mexican Spanish
- Euskera
- Finnish
- French
- Galego
- Canadian French
- Hungarian
- Italian
- Dutch
- Dutch (Netherlands)
- Norwegian
- Polish
- Portuguese
- Portuguese Brazilian
- Romanian
- Russian

- Slovak
- Swedish
- Turkish

You can also configure the language to use when inputting values in the Mitel Web UI and the IP phone UI.

Specifying the Language to Use

Once the language pack(s) are available on your phone from your System Administrator, you can specify which language to use on the phone and/or the Mitel Web UI.

NOTE: All languages may not be available for selection. The available languages are dependent on the language packs currently loaded to the IP phone.

IP Phone UI

1. Press  on the phone to enter **Options** List.
2. Select **Preferences**.
3. Select **Language**.
4. Select **Screen Language**. The language setting displays a check mark indicating this is the current language on the IP phone.
5. Using the **▲** and **▼** keys, **scroll through the languages**.

NOTE: All languages may not be available for selection. The available languages are dependent on the language packs currently loaded to the IP phone. English is the default language and cannot be changed or removed. For more information about loading language packs, see your System Administrator.

6. Press the  key or select **▶ Set** to set the language on the phone. The change is dynamic. When you exit the Options List, the phone displays all menu items in the language you selected.

Mitel Web UI

1. Click on **Basic Settings > Preferences > Language Settings**.

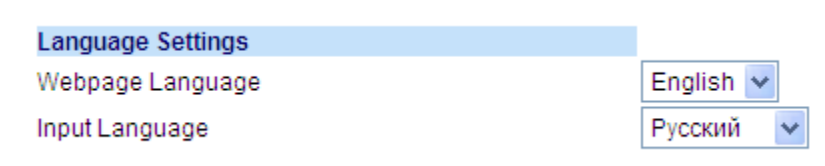

2. In the **Webpage Language** field, select a language to apply to the Mitel Web UI.

NOTE: All languages may not be available for selection. The available languages are dependent on the language packs currently loaded to the IP phone by your System Administrator. English is the default language and cannot be changed or removed.

- 3.
4. Click **Save Settings**. The change is dynamic. The Mitel Web UI displays all screens in the language you selected.

NOTE: You must have the language pack(s) already loaded to your phone in order to use them. For more information about loading language packs, see your System Administrator.

Input Language

The 6905 supports text and character inputs in various languages (English, German, French, Spanish, Italian, Portuguese, Russian, and Nordic). Inputting textual or character information into the IP phone UI can be done using the keypad on the phone. You can configure the **Input Language** feature using the Mitel Web UI or the IP phone UI.

The following tables identify the language characters that you can use to enter text and characters on the 6905.

Keypad Input Alphabet Tables

English (default)

KEY	UPPERCASE CHARACTERS	LOWERCASE CHARACTERS
0	0+	0+
1	1.;=_,-'&()[]\$!	1.;=_,-'&()[]\$!
2	ABC2	abc2
3	DEF3	def3
4	GHI4	ghi4
5	JKL5	jkl5
6	MNO6	mno6
7	PQRS7	pqrs7
8	TUV8	tuv8
9	WXYZ9	wxyz9
*	* <SPACE>	* <SPACE>
#	#\@	#\@

French

KEY	UPPERCASE CHARACTERS	LOWERCASE CHARACTERS
0	0+	0+
1	1.;=_,-'&()[]\$!	1.;=_,-'&()[]\$!
2	ABC2ÀÂÇÁÀÆ	abc2àâçáàæ
3	DEF3ÉÈÊË	def3éèêë
4	GHI4Ï	ghi4ï

KEY	UPPERCASE CHARACTERS	LOWERCASE CHARACTERS
5	JKL5	jkl5
6	MNO6ÑÓÒÖ	mno6ñóòö
7	PQRS7	pqrs7
8	TUV8	tuv8úùûü
9	WXYZ9	wxyz9
*	* <SPACE>	* <SPACE>
#	#\@	#\@

Spanish

KEY	UPPERCASE CHARACTERS	LOWERCASE CHARACTERS
0	0+	0+
1	1.;;=_,-'&()[]\$!	1.;;=_,-'&()[]\$!
2	ABC2ÁÀÇ	abc2áàç
3	DEF3ÉÈ	def3éè
4	GHI4Í	ghi4í
5	JKL5	jkl5
6	MNO6ÑÓÒ	mno6ñóò
7	PQRS7	pqrs7
8	TUV8ÚÛ	tuv8úû
9	WXYZ9	wxyz9
*	* <SPACE>	* <SPACE>
#	#\@	#\@

German

KEY	UPPERCASE CHARACTERS	LOWERCASE CHARACTERS
0	0+	0+
1	1.;;=_,-'&()[]\$!	1.;;=_,-'&()[]\$!
2	ABC2ÄÀ	abc2ää
3	DEF3É	def3é
4	GHI4	ghi4

KEY	UPPERCASE CHARACTERS	LOWERCASE CHARACTERS
5	JKL5	jkl5
6	MNO6Ö	mno6ö
7	PQRS7ß	pqrs7ß
8	TUV8Ü	tuv8ü
9	WXYZ9	wxyz9
*	* <SPACE>	* <SPACE>
#	#\@	#\@

Italian

KEY	UPPERCASE CHARACTERS	LOWERCASE CHARACTERS
0	0+	0+
1	1.;;=_,'&()[]\$!	1.;;=_,'&()[]\$!
2	ABC2ÀÇ	abc2àç
3	DEF3ÉÈË	def3éèë
4	GHI4	ghi4
5	JKL5	jkl5
6	MNO6ÓÒ	mno6óò
7	PQRS7	pqrs7
8	TUV8Ü	tuv8ü
9	WXYZ9	wxyz9
*	* <SPACE>	* <SPACE>
#	#\@	#\@

Portuguese

KEY	UPPERCASE CHARACTERS	LOWERCASE CHARACTERS
0	0+	0+
1	1.;;=_,'&()[]\$!	1.;;=_,'&()[]\$!
2	ABC2ÁÂÃÇ	abc2áâãç
3	DEF3ÉÊ	def3éê
4	GHI4Í	ghi4í

KEY	UPPERCASE CHARACTERS	LOWERCASE CHARACTERS
5	JKL5	jkl5
6	MNO6ÓÔÕ	mno6óôõ
7	PQRS7	pqrs7
8	TUV8ÚÛ	tuv8úû
9	WXYZ9	wxyz9
*	* <SPACE>	* <SPACE>
#	#\#@	#\#@

Russian

KEY	UPPERCASE CHARACTERS	LOWERCASE CHARACTERS
0	0+	0+
1	1.;;=_,-'&()[]\$!	1.;;=_,-'&()[]\$!
2	ÀÁÂÃ2ABC	àáâã2abc
3	ДЕЁЖЭЗDEF	деёжэзdef
4	ИЙКЛ4GHI	ийкл4ghi
5	МНОП5JKL	мноп5jkl
6	РСТУ6MNO	рсту6mno
7	ФХЦЧ7PQRS7	фхчч7pqrs
8	ШЩЪЫ8TUV	шщъы8tuv
9	ЪЗЮЯ9WXYZ	ъзюя9wxyz
*	* <SPACE>	* <SPACE>
#	#\#@	#\#@

Nordic

KEY	UPPERCASE CHARACTERS	LOWERCASE CHARACTERS
0	0+	0+
1	1.;;=_,-'&()[]\$!	1.;;=_,-'&()[]\$!
2	ABC2ÅÄÆÀ	abc2åäæà
3	DEF3É	def3é
4	GHI4	ghi4

KEY	UPPERCASE CHARACTERS	LOWERCASE CHARACTERS
5	JKL5	jkl5
6	MNO6ÖØ	mno6öø
7	PQRS7ß	pqrs7ß
8	TUV8Ü	tuv8ü
9	WXYZ9	wxyz9
*	* <SPACE>	* <SPACE>
#	#\#@	#\#@

Configuring Language Input Using the IP Phone UI

You can configure the language you use for inputting on the phone by setting the **Input Language** option. The default input language setting is English.

IP Phone UI

1. Press  on the phone to enter the **Options** List.
2. Select **Preferences**.
3. Select **Language**.
4. Select **Input Language**. Select the language you want to use when inputting text and characters into the IP phone UI. Valid values are:
 - English (default)
 - Français (French)
 - Español (Spanish)
 - Deutsch (German)
 - Italiano (Italian)
 - Português (Portuguese)
 - Русский (Russian)
 - Nordic

NOTE: Available input languages are dependent on the configuration enabled by your System Administrator.

5. Press the  key or select **► Set** to set an input language.

Mitel Web UI

1. Click on **Basic Settings > Preferences > Language Settings**.

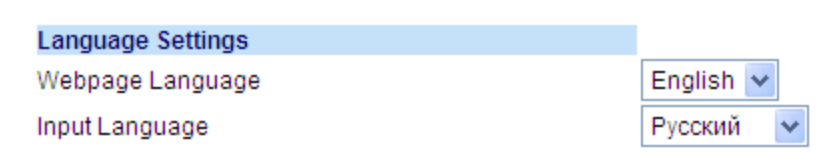

2. Select a language from the **Input Language field**. Setting this field allows you to specify the language to use when entering text and characters in the Mitel Web UI and IP phone UI. Valid values are:
 - English (default)
 - Français (French)
 - Español (Spanish)
 - Deutsch (German)
 - Italiano (Italian)
 - Português (Portuguese)
 - Русский (Russian)
 - Nordic

NOTE: All languages may not be available for selection. The available input languages are dependent on the configuration enabled by your System Administrator.
3. Click **Save Settings**. The change is dynamic. The Mitel Web UI and IP phone UI allow you to enter text and characters in the language you selected.

Latin 2 Character Set

The 6905 includes support for ISO 8859-2 (Latin2) of multi-national languages when displaying and inputting in the IP phone UI and the Mitel Web UI. UTF-8 is also compatible with XML encoding on the IP phones.

The following table illustrates the Latin 2 character set used on the 6905 IP phone.

	-0	-1	-2	-3	-4	-5	-6	-7	-8	-9	-A	-B	-C	-D	-E	-F
A-	NBSP 00A0 160	Ą 0104 161	˘ 02D8 162	Ł 0141 163	ϣ 00A4 164	Ĺ 013D 165	Ś 015A 166	§ 00A7 167	¨ 00A8 168	Š 0160 169	Ş 015E 170	Ť 0164 171	Ž 0179 172	SHY 00AD 173	Ž 017D 174	Ž 017B 175
B-	° 00B0 176	ą 0105 177	˘ 02DB 178	ł 0142 179	´ 00B4 180	ĺ 013E 181	ś 015B 182	˘ 02C7 183	¸ 00B8 184	š 0161 185	ş 015F 186	ť 0165 187	ž 017A 188	” 02DD 189	ž 017E 190	ž 017C 191
C-	Ř 0154 192	Á 00C1 193	Â 00C2 194	Ă 0102 195	Ä 00C4 196	Í 0139 197	Ć 0106 198	Ç 00C7 199	Č 010C 200	É 00C9 201	Ę 0118 202	Ë 00CB 203	Ě 011A 204	Í 00CD 205	Î 00CE 206	Ď 010E 207
D-	Đ 0110 208	Ń 0143 209	Ň 0147 210	Ó 00D3 211	Ô 00D4 212	Ó 0150 213	Ö 00D6 214	× 00D7 215	Ř 0158 216	Ů 016E 217	Ú 00DA 218	Ů 0170 219	Û 00DC 220	Ý 00DD 221	Ť 0162 222	ß 00DF 223
E-	ř 0155 224	á 00E1 225	â 00E2 226	ă 0103 227	ä 00E4 228	í 013A 229	ć 0107 230	ç 00E7 231	č 010D 232	é 00E9 233	ę 0119 234	ë 00EB 235	ě 011B 236	í 00ED 237	î 00EE 238	ď 010F 239
F-	đ 0111 240	ń 0144 241	ň 0148 242	ó 00F3 243	ô 00F4 244	ó 0151 245	ö 00F6 246	÷ 00F7 247	ř 0159 248	ů 016F 249	ú 00FA 250	ů 0171 251	ü 00FC 252	ý 00FD 253	ť 0163 254	· 02D9 255

User Password

This category allows you to change the user password for your phone. Changing your password ensures that only you can alter your phone settings, and helps keep your system secure. You can change your user password using the IP phone UI or the Mitel Web UI.

CONFIGURING A USER PASSWORD

If unsupported characters are present in the user password or if the password length exceeds 15 characters in the configuration file then the phone uses the default password. The default password for user is blank.

The following full character sets are supported:

- 0-9
- A-Z
- a-z
- +,.,=,_,-'&()\$!*/@

NOTE: User password does not support space and pound in the configuration file.

Setting a User Password

IP Phone UI

1. Press  on the phone to enter the Options List.
2. Select **Password**.
3. At the **Current Password** prompt, enter the current user password and press the key or select **Done**.
4. At the **New Password** prompt, enter the new user password and press the key or select **Done**.
5. At the **Enter Again** prompt, re-enter the new user password and press the key or select **Done**. A message, **Password Changed** displays on the screen.

Mitel Web UI

1. Click on **Operation > User Password**.

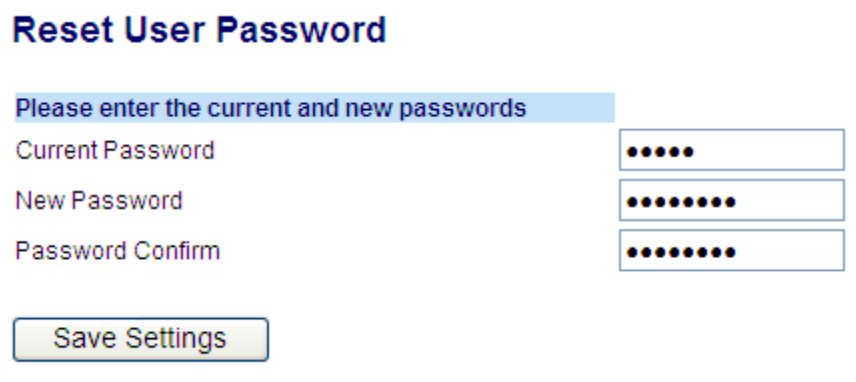

Reset User Password

Please enter the current and new passwords

Current Password

New Password

Password Confirm

2. In the **Current Password** field, enter the current user password.

NOTE: By default, the user name is user (all lowercase) and the password field is left blank.
3. In the **New Password** field, enter the new user password.
4. In the **Password Confirm** field, enter the new user password again.
5. Click **Save Settings**.

Resetting a User Password

If you forget your password, you can reset it and enter a new password. The reset user password feature resets the password to the factory default which is blank (no password). You can reset a user password using the Mitel Web UI only.

NOTE: The IP phones support alphanumeric password with the supported characters.

Mitel Web UI

1. Click on **Operation > Phone Lock**.

Phone Lock

Settings

Emergency Dial Plan

Lock or unlock the phone

Lock the phone?

Reset User Password

2. Click on the **Reset User Password** field, click **Reset** . The following screen displays

Reset User Password

Please enter the current and new passwords

Current Password

New Password

Password Confirm

3. In the **Current Password** field, leave this blank.
4. In the **New Password** field, enter a new password.
5. In the **Password Confirm** field, re-enter your new user password.
6. Click **Save Settings**.

Restarting Your Phone

You may want to restart your phone to check for updates on the server or you may occasionally need to restart your phone for configuration changes to your phone or network settings to take effect. You may also need to restart your phone if you have been asked to do so by your System Administrator or should you experience any unexpected behavior.

IP Phone UI

1. Press the  key on the phone to enter the Options List.
2. Select **Restart Phone** .

3. Press **# Confirm** to confirm the restart of the phone. If you do not wish to restart your phone, press the **◀ Cancel** key to cancel.

NOTE: Your phone is out of service temporarily during the restart and downloading process.

Mitel Web UI

1. Click on **Operation > Reset**.

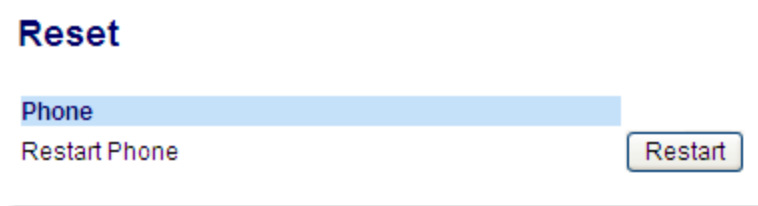

2. Click **Restart**.
3. Click **OK**.

Credentials

NOTE: Menu available only if certain features requiring authentication to a server have been configured by your Administrator.

Some features (e.g. LDAP Directory, Microsoft Exchange Directory, BroadSoft Xsi features, etc...) require authentication to external servers before they can be used. The **Credentials** options menu allows you to enter in your user credentials for these respective features.

Entering Usernames/Passwords and Connection Testing Using the IP Phone UI

1. Press  on the phone to enter the Options List.
2. Select **Credentials**.
3. Use the **▲ and ▼** keys to navigate to the desired feature and select **▶ Enter**.
4. Press the **▲** key to navigate to the Enter Username screen and select **▶ Enter**.
5. Using the dialpad keys, enter in your username and select **▶ Set**.

NOTE: The **◀** key can be used to perform a backspace.

6. Press the **▲** key to navigate to the Enter Password screen and select **▶ Enter**.
7. Using the dialpad keys, enter in your password and press the button or select **▶ Set**.

NOTE: The **◀** key can be used to perform a backspace.

Directory

You can configure directory entries to display using the contact's first name and then last name or vice versa. Moreover, the option to sort contacts using either their first name or last name is available. If external Directory sources are configured, you can enable/disable the respective Directory sources as well as rename Directory folder labels in this menu.

NOTE: For more information on Directory functionality, see [“Directory”](#).

Configuring Directory Display and Sorting Options Using the IP Phone UI

1. Press  on the phone to enter the Options List.
2. Select **Directory**.
3. Navigate to **Display Name Order** and select **▶ Enter**.
4. Use the **▲ and ▼** keys to and choose the desired display name order and press the **button or select ▶ Set**.

The display name order you selected is immediately applied to the phone.

5. Navigate to **Sorting Preferences** and select **▶ Enter**.
6. Use the **▲ and ▼** keys to and choose the desired sorting preference and press the **button or select ▶ Set**.

The sorting preference you selected is immediately applied to the phone.

Enabling/Disabling Directories and Renaming Labels Using the IP Phone UI

NOTE: This option is only available if external Directory sources have been configured by your Administrator.

1. Press  on the phone to enter the Options List.
2. Select **Directory**.
3. Navigate to **External Sources** and select **▶ Enter**.
4. Use the **▲ and ▼** keys to navigate through the list of Directory sources and select **▶ Enter**.
5. Navigate to **State** and press the **▶ Enter** key.
6. Use the **▲ and ▼** keys to and choose the desired state and press the **button or select ▶ Set**. The state you selected is immediately applied to the phone.
7. Navigate to **Label** and press the **▶ Enter** key.

- Using the dialpad keys, enter in the new label and press the  **button or select** ► **Set** when finished. The new label is immediately applied to the phone.

Phone Lock

You can lock your phone to prevent the phone from being used or configured. You can lock the phone using any of the following:

- At the path *Options > Phone Lock* on the IP phone UI.
- At the path *Operations > Phone Lock* on the Mitel Web UI.
- At a configured key on the phone. For more information about configuring a Lock/Unlock key on your phone, see [Phone Lock Key](#).

In the Mitel Web UI, the *Operation > Phone Lock* path also allows you to perform the following:

- Reset a user password. Clicking on the **Reset** key in the **Reset User Password** field displays a screen that allows you to enter and save a new user password.
- Set an emergency dial plan. An emergency dial plan can be 911, 999, 112, 110 or all of the above. The default emergency dial plan is 911|999|112|110.

The following procedures describe locking the phone, setting an emergency dial plan, and resetting the user password.

Locking/Unlocking a Phone



Use the following procedures to lock an IP phone and prevent it from being used or configured.

Locking the Phone IP Phone UI

- Press  on the phone to enter the Options List.
- Select **Phone Lock**.
- At the **Lock the phone?** prompt select ► **Yes**.
- The message **Phone is locked** displays.

NOTE: Alternatively, if configured, you can lock the phone by simply pressing a **Lock** programmable key.

Unlocking the Phone

- Press  on the phone to enter the Options List (or press a configured **Lock** programmable key).
- At the prompt **Password:**, enter your user password and press the  key or select ► **Enter**.

The phone unlocks.

Mitel Web UI

1. Click on **Operation > Phone Lock**.

Phone Lock

Settings

Emergency Dial Plan

Lock or unlock the phone

Lock the phone?

Reset User Password

Locking the Phone

2. In the **Lock the Phone?** field, click **Lock** . The phone locks dynamically and displays the following message: **Phone is locked**.

Unlocking the Phone

3. Click on **Operation > Phone Lock**.
4. In the **Unlock the Phone?** field, click **Unlock**. The phone unlocks dynamically and displays the following message: **Phone is unlocked**.

Emergency Dial Plan

Public telephone networks in countries around the world have a single emergency telephone number (emergency services number), that allows a caller to contact local emergency services for assistance when required. The emergency telephone number may differ from country to country. It is typically a three-digit number so that it can be easily remembered and dialed quickly. Some countries have a different emergency number for each of the different emergency services.

You can specify the digits to dial on the IP phone for contacting emergency services. Once you specify the emergency number(s) on the phone, you can dial those numbers directly on the keypad when required and the phone automatically dials to those emergency services.

You can set the emergency dial plan using the Mitel Web UI only.

NOTE:

1. Emergency dial plan pattern matching is only functional when the live dialpad feature is enabled. For more information on the live dialpad feature, see [“Live Dialpad”](#).
2. Contact your local phone service provider for available emergency numbers in your area.

The following table describes the default emergency numbers on the IP phones.

Emergency Number	Description
911	A United States emergency number.
999	A United Kingdom emergency number.

Emergency Number	Description
112	An international emergency telephone number for GSM mobile phone networks. In all European Union countries it is also the emergency telephone number for both mobile and fixed-line telephones.
110	A police and/or fire emergency number in Asia, Europe, Middle East, and South America.

Defining an Emergency Dial Plan

Mitel Web UI

1. Click on **Operation > Phone Lock**.

Phone Lock

The screenshot shows the 'Phone Lock' configuration page. Under the 'Settings' section, the 'Emergency Dial Plan' field is populated with '911|999|112|110'. Below this, there are two buttons: 'Lock' and 'Reset'. At the bottom of the settings area, there is a 'Save Settings' button.

2. In the **Emergency Dial Plan** field, enter the 3-digit number used in your local area to contact emergency services. For multiple numbers, enter a | between each emergency number.

For example:

911|110

Default for this field is **911|999|112|110**.

3. Click **Save Settings** to save the emergency dial plan to your phone.

Line Key and Programmable Keys

This section describes the Single Line/Call Appearance Key and the customizable programmable keys located under the phone's LCD screen.

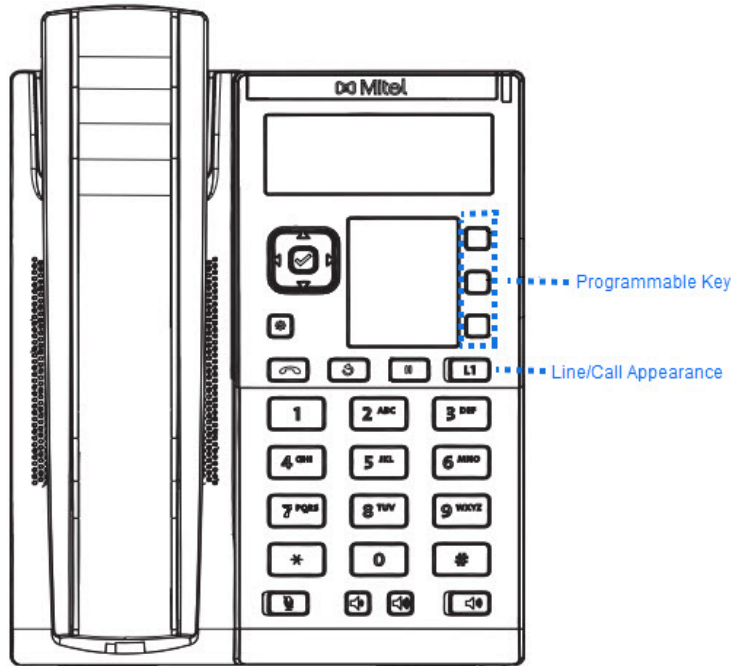

Line and Call Appearance Keys

The 6905 has one hard line/call appearance keys with a status light. This line/call appearance key and light can represent physical line, calls for your extension or calls from a group that your extension is part of. The line/call appearance light indicates the status of that line or call.

LINE/CALL APPEARANCE LED BEHAVIOR	LINE/CALL APPEARANCE STATUS
Off	Idle line or no call activity
Light flashes quickly	Ringing
Light is solid	Connected
Light flashes slowly	Hold

Programmable Keys

There are three multi-functional keys on the 6905 phone that are programmable.

You can only use the Mitel Web UI to configure key functions. The following table lists the functions you can set on the programmable keys and provides a description for each function:

KEY FUNCTION	DESCRIPTION
None	Indicates the key has no function assigned.
Speeddial	Indicates the key is configured for speeddial use.
Do Not Disturb	Indicates the key is configured for Do Not Disturb (DND) functionality.
XML	Indicates the key is configured to accept an XML application for accessing customized XML services.
Flash	Indicates the key is set to generate a flash event when it is pressed. The IP phone generates flash events only when a call is connected and there is an active RTP stream (for example, when the call is not on hold).
Sprecode	Indicates the key is configured to automatically activate specific services offered by the server. For example, if the sprecode value of *82 is configured, then by pressing the Sprecode key, *82 automatically activates a service provided by the call manager.
Park	Indicates the key is configured to park incoming calls when pressed.
Pickup	Indicates the key is configured to pick up parked calls when pressed.
Last Call Return	Indicates the key is configured for Last Call Return functionality when pressed.
Call Fwd	Indicates the key is configured as a Call Forward key. When pressed, the IP phone UI displays the Call Forward menus.
Speeddial/Xfer	Indicates the key is configured as a simplified speed dial key and a transfer key. You can use this key to perform speed dial functions as well as use it as a transfer key to transfer calls.
Speeddial/Conf	Indicates the key is configured as a speed dial key and a conference key. You can use this key to speed dial from within a conference call and add the new call directly to the conference.
Directory (Key 2 by Default)	Indicates the key is configured to access the Directory.

KEY FUNCTION	DESCRIPTION
Callers List (Key 1 by Default)	Indicates the key is configured to access the Callers List.
Redial	Indicates the key is configured to access the Redial List.
Conference	Indicates the key is configured to initiate a conference call.
Transfer (Key 3 by Default)	Indicates the key is configured to initiate a call transfer.
Icom	Indicates the key is configured to be used for intercom calls.
Services	Indicates the key is set to access Services, such as, Directory, Callers List, Voicemail, or any other XML applications set up by your System Administrator.
Phone Lock	Indicates the key is configured as a phone lock key, allowing you to press this key to lock/unlock the phone.
Paging	Indicates the key is configured as a Paging key. When pressed, the phone can send Real Time Transport Protocol (RTP) streams from a pre-configured multicast address without involving SIP signaling.
Save	Indicates the key is configured as a dedicated Save key.
Delete	Indicates the key is configured as a dedicated Delete key.
Login	Indicates the key is configured as a Visitor Desk Phone (VDP) Login key. For VDP feature availability and details, please contact your System Administrator.
Discreet Ringing	Indicates the key is configured as a Discreet Ringing key. When the Discreet Ringing feature is enabled, if a call is incoming, the phone will play the configured ring tone once only. Pressing the Discreet key will allow you to toggle on/off the feature.

NOTE: Keys can also be set up to quickly to access features such as call return (*69) or voicemail. Quick access features like call return and voicemail must first be configured on your PBX in order to work on your phone. See your System Administrator for more information.

Creating a Speed Dial Key

The normal function of the speed dial option allows you to dial a number quickly by pressing a key configured for speed dialing. You can program the keys on the 6905 to speed dial outside numbers, dial directly to another person's line or extension, or set it up to quickly access features such as Caller ID (*69) and voicemail.

The speed dial function can be set using the IP phone UI or the Mitel Web UI .

NOTE: You can use a speed dial key while on an active call by placing the active call on hold first, and then pressing the speed dial key.

You can create speed dial keys using any of the following methods:

- Using the Mitel Web UI at the paths:
 - Operation > Programmable Keys
 - Operation > Keypad Speed Dial
- By pressing and holding a programmable key or keypad key
- Using the IP phone UI at the path:
 - Options > Preferences > Speed Dial Edit

Speed Dial Prefix

The speed dial feature also allows you to specify a preset string of numbers followed by a + that the phone dials automatically after pressing the speed dial key. You can use this feature for numbers that contain long prefixes.

For example, if you had the following speed dial configuration in the Mitel Web UI:

Key 1
Type: Speeddial
Value: 1234567+
Line: 2

Then, after you press key 1 on the phone, the prefix number displays on the phone screen. The phone proceeds to dial the prefix number automatically and pauses for you to enter the remaining phone number using the keypad on the phone.

Use the following procedures to set speed dial on the 6905 IP phone.

Press-and-Hold to Create a Speed Dial (applicable to programmable keys and keypad keys)

Pressing and holding down a programmable key or keypad key on the phone initiates a speed dial feature.

NOTE: When creating a speed dial for a key on the IP phone, you must select a key that has no preassigned function (key must be set to **None**)

IP Phone UI

1. Press a programmable key or a number key on the keypad for three seconds. A screen displays with the prompt, **Enter Number>** .

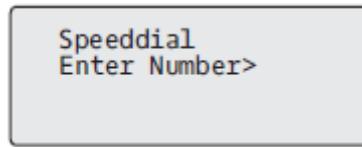

2. Enter a phone number or extension to assign to that speed dial key. The following example illustrates the screen display:

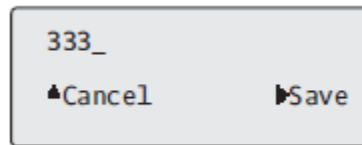

3. Press **Save** to save the number as a speed dial key.

By default, the phone automatically assigns the speed dial key to line 1 if available. To select a different line, use the **▲** and **▼** navigation keys.

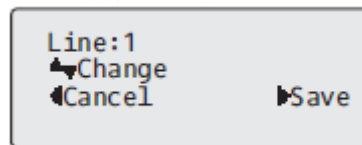

4. Press **Save** to save the speed dial key to the line specified.

Creating a Speed Dial Using the Speed Dial Edit Option

You can use the IP phone UI at the path, *Options > Preferences > Speed Dial Edit* , to create a speed dial key.

IP Phone UI

1. Press  on the phone to enter the Options List.
2. Select **Preferences**.
3. Select **Speed Dial Edit** .

The following prompt displays:
Press SD button

NOTE: If you select a key that is currently set as a speed dial key, the speed dial information displays for you to edit

4. Press an unconfigured programmable key or keypad key.

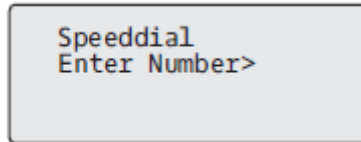

5. Enter a phone number or extension to assign to that speed dial key. The following example illustrates the screen display:

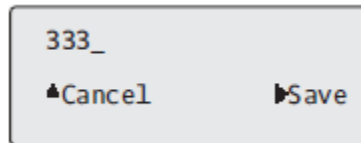

6. Press 4 **Save** to save the number as a speed dial key. By default, the phone automatically assigns the speed dial key to line 1 if available. To select a different line, use the **▲** and **▼** navigation keys.

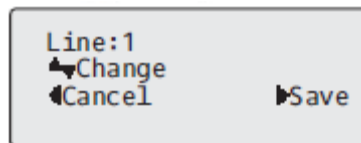

7. Press **▶ Save** to save the speed dial key to the line specified.

Creating a Speed Dial Using a Programmable Key in the Mitel Web UI

1. Click on **Operation > Programmable Keys**.

Programmable Keys Configuration

Key	Type	Value	Line
1	Speeddial	123456+	1
2	None		1
3	None		1

2. Select from **Key 1** through **Key 3**.
3. In the **Type** field, select **Speeddial** to apply to the key.
4. In the **Value** field, enter the phone number, extension, or speed dial prefix to apply to this hard key. If you enter a speed dial prefix, you must enter the + character at the end of the prefix number (for example, 123456+).
5. In the **Line** field, select a line for which to apply the speed dial to. Valid values are **1** and **2**.
6. Click **Save Settings**.

Creating Speed Dial Key Using Keypad Speed Dial in the Mitel Web UI

1. Click on **Operation > Keypad Speed Dial**

Keypad Speed Dial

Key	Value	Line
1	123456+	1
2		1
3		1
4		1
5		1
6		1
7		1
8		1
9		1

2. Select from **Key 1** through **Key 9**.
3. In the input box, enter the phone number, extension, or speed dial prefix to apply to this Digit key. If you enter a speed dial prefix, you must enter the + character at the end of the prefix number (for example, 123456+).
4. In the **Line** field, select a line for which to apply the speed dial to. Valid values are **1** and **2**.
5. Click **Save Settings**.

Editing Speed Dial Keys

On the 6905, you can edit a speed dial key using any of the following methods:

- Using the Mitel Web UI at the path:
 - Operation > Programmable Keys
 - Operation > Keypad Speed Dial
- Using the IP phone UI at the path:
 - Options > Preferences > Speed Dial Edit.

NOTE: A speed dial key must be already configured on the phone to edit the key.

IP Phone UI

1. Press  on the phone to enter the Options List.
2. Select **Preferences**.
3. Select **Speed Dial Edit**.
4. Press a speed dial key you want to edit. The speed dial edit screen displays.

NOTE:

- a. If a number on the keypad is setup as a speed dial key, pressing the applicable number in the speed dial editing process also displays the speed dial edit screen. The edit screen allows you to change the **Speed Dial Number** and **Line** setting.
 - b. If you press a key that is NOT setup as a speed dial key, the phone displays an **Invalid Key** message. However, if you press an empty keypad key or programmable key that is set to **None**, it initiates the Add a Speed Dial Key process allowing you to setup a new speed dial key.
5. Edit the speed dial information as applicable and press 4 **Save** .

NOTE:

- a. You can cancel out of the speed dial editing process at any time without saving, by pressing the  key.
- b. On the 6905, you can remove the speed dial key by erasing the speed dial number digits (leaving the speed dial value blank) and then pressing 4 **Save** . Use the 3 key to delete the digits.

Editing a Speed Dial on a Programmable Key

Mitel Web UI

1. Click on **Operation > Programmable Keys**.

Programmable Keys Configuration

Key	Type	Value	Line
1	Speeddial	123456+	1
2	None		1
3	None		1

2. Select the key configured for speed dial.
3. In the **Value** field, edit the phone number, extension, or speed dial prefix to apply to this hard key. If you enter a speed dial prefix, you must enter the + character at the end of the prefix number (for example, 123456+).
4. If required in the **Line** field, select a line for which to apply the speed dial to. Valid values are 1 and 2.
5. Click **Save Settings**.

NOTE: You can delete a speed dial key by changing the **Type** field to **None** .

Editing a Speed Dial Using Keypad Speed Dial in the Mitel Web UI

1. Click on **Operation > Keypad Speed Dial**.

Keypad Speed Dial

Key	Value	Line
1	<input type="text" value="123456+"/>	<input type="text" value="1"/>
2	<input type="text"/>	<input type="text" value="1"/>
3	<input type="text"/>	<input type="text" value="1"/>
4	<input type="text"/>	<input type="text" value="1"/>
5	<input type="text"/>	<input type="text" value="1"/>
6	<input type="text"/>	<input type="text" value="1"/>
7	<input type="text"/>	<input type="text" value="1"/>
8	<input type="text"/>	<input type="text" value="1"/>
9	<input type="text"/>	<input type="text" value="1"/>

2. Select from **Key 1** through **Key 9**.
3. In the input box, edit the phone number, extension, or speed dial prefix for this Digit key. If you enter a speed dial prefix, you must enter the + character at the end of the prefix number (for example, 123456+).
4. In the **Line** field, select a line for which to apply the speed dial to. Valid values are 1 and 2.
5. Click **Save Settings**.

Do Not Disturb (DND) Key

The IP phones have a feature you can enable called Do Not Disturb (DND). Configuring a **DND** key allows you to quickly turn the DND feature on or off.

If DND is enabled, callers calling into the phone hear a busy signal or a message, depending on how your System Administrator set up the configuration server. The second line on the screen of the IP phone shows when DND is set.

If the phone shares a line with other phones, only the phone that has DND configured is affected.

For more information about DND and DND modes, see [DND Configuration](#).

Configuring a DND Key

Mitel Web UI

1. Click on **Operation > Programmable Keys**.

Programmable Keys Configuration

Key	Type	Value	Line
1	Do Not Disturb		1
2	None		1
3	None		1

2. Select from **Key 1** through **Key 3**.
3. In the **Type** field, select **Do Not Disturb**.
4. Click **Save Settings** to save the **DND** key setting.

XML Key

The 6905 IP phone has a feature you can enable called **XML** (Extensible Markup Language). XML is a markup language much like HTML. Your System Administrator can create customized XML applications and load them to your IP phone. These services include things like weather and traffic reports, contact information, company info, stock quotes, or custom call scripts. You can configure XML using the Mitel Web UI only.

Using the Mitel Web UI, you can configure a key to access XML applications. Under **Operations > Programmable Keys** you can assign a key the type **XML**.

After an **XML** key is configured, you can use the IP phone UI to access the XML applications.

NOTE: The XML services must be set up by your System Administrator before you can use the key. Contact your System Administrator for more information.

You can also specify an XML URI and a Services title using the following XML fields:

- XML Application URI
- XML Application Title

The **XML Application URI** is the URI loaded by your phone when accessing XML services through the Services menu. Contact your System Administrator for the applicable XML URI to enter in the XML Application URI field.

NOTE: Contact your System Administrator for the applicable URI to enter in this field.

If you use the Services key to access the XML features, the **XML Application Title** is the title that displays on the Services Menu in the IP phone UI.

Configuring an XML Key

Mitel Web UI

1. Click on **Operation > Programmable Keys**

Programmable Keys Configuration

Key	Type	Value	Line
1	XML	http://192.168.0.120/xml/menu/menu.php?source=a	1
2	None		1
3	None		1

Services

XML Application URI:	tp://192.168.0.120/xml/menu/menu.php?source=all
XML Application Title:	XML Menu
BLF List URI:	

Save Settings

2. Select from **Key 1** through **Key 3**.
3. In the **Type** field, select **XML** to apply to the key.
4. In the **Value** field, enter a URI(s) to apply to this key.

NOTE:

- a. Contact your System Administrator for the appropriate value to enter in the Value field.
 - b. If you specify multiple URIs in the **Value** field, a list of XML applications appears for selection after pressing the **XML** key.
5. To access XML services through the Services menu, in the **XML Application URI** field, enter the XML application URI provided by your System Administrator.
 6. In the **XML Application Title** field, enter the XML application title that you want to display as the Services menu title on your phone.
 7. Click **Save Settings** .

Accessing the XML Application

After XML applications have been saved to your IP phone, and after a key has been configured to access the XML application(s), the customized service is ready for you to use.

IP Phone UI

1. Press the key configured for XML on the 6905 phone.
2. Use the ▲ and ▼ to scroll through the XML applications.

- For menu and directory services, select a service to display the information for that customized service. Message services display to the screen after pressing the key. For user input services, follow the prompts as appropriate.
- To exit from the XML screen, press the  key.

Flash Key

You can set a programmable key to generate a flash event when it is pressed on the 6905. You do this by setting the key to **Flash**. The IP phone generates flash events only when a call is connected and there is an active RTP stream (for example, when the call is not on hold).

Configuring a Flash Key

Mitel Web UI

- Click on **Operation > Programmable Keys**.

Programmable Keys Configuration

Key	Type	Value	Line
1	Flash		1
2	None		1
3	None		1

- Select from **Key 1** through **Key 3**.
- In the **Type** field, select **Flash**.
- Click **Save Settings**.

Sprecode Key

You can set a programmable key to automatically activate specific services offered by the server. For example, if the sprecode value of *82 is configured, then by pressing the Sprecode key, *82 automatically activates a service provided by the server. Contact your System Administrator for information about available services.

Configuring a Sprecode Key

Mitel Web UI

1. Click on **Operation > Programmable Keys**.

Programmable Keys Configuration

Key	Type	Value	Line
1	Sprecode	*82	1
2	None		1
3	None		1

2. Select from **Key 1** through **Key 3**.
3. In the **Type** field, select **Sprecode**.
4. In the **Value** field, enter the appropriate value for accessing specific services from the server.

NOTE: For values to enter in this field, contact your System Administrator.
5. Click **Save Settings**.

Park/Pickup Keys

The 6905 phone has a park and pickup call feature that allows you to park a call and pickup a call when required. The IP phones support the Park/Pickup feature on the Asterisk, BroadWorks, Sylanro, and ININ call managers.

The park/pickup feature performs as follows:

- When a call comes in and you pickup the handset, you can press the applicable **Park** key to park the call
- After the call is parked, you can press the **Pickup** key, followed by the applicable value to pickup the call

Administrators can configure the **Park** and **Pickup** keys for any line using the configuration files or the Mitel Web UI.

Configuring Park/Pickup Keys

Mitel Web UI

1. Click on **Operation > Programmable Keys**.

Programmable Keys Configuration

Key	Type	Value	Line
1	Park	*68	1
2	Pickup	*88	1
3	None		1

2. Select from **Key 1** through **Key 3**.

3. In the **Type** field, select **Park**.

NOTE: The **Value** field should be configured by the Administrator.

4. Select from **Key1** through **Key 3**.

5. In the **Type** field, select **Pickup**.

NOTE: The **Value** field should be configured by the Administrator.

6. Click **Save Settings**.

7. Click on **Reset**, then click **Restart** to restart the IP phone and apply the changes.

Using the Park Call/Pickup Parked Call Feature

Use the following procedure on the IP phone to park a call and pick up a parked call.

Parking a Call

1. While on a live call, press the **Park** key.
2. Perform the following for your specific server:

ASTERISK
Server announces the extension number where the call has been parked. Once the call is parked, press the  key to complete parking.
BROADWORKS
After you hear the greeting from the CallPark server, enter the extension where you want to park the call.
SYLANTRO
Enter the extension number where you want to park the call, followed by # key.
ININ

Enter the extension number where you want to park the call, followed by # key.

If the call is parked successfully, the response is either a greeting voice confirming that the call was parked, or a hang up occurs. The parked call party hears music on hold.

3. If the call fails, you can pick up the call (using the next procedure) and press the **Park** key again to retry Step 2.

Picking Up a Parked Call

1. Pick up the handset on the phone.
2. Enter the extension number where the call was parked.
3. Press the **Pickup** key. If the call pick up is successful, you are connected with the parked call.

Last Call Return Key

Using the Mitel Web UI, you can configure the Last Call Return function on a key. If you configure Last Call Return on a key, and a call comes into your phone, after you are finished with the call and hang up, you can press the key configured for Last Call Return and the phone dials the last call you received. When the Sylanro call manager detects an Last Call Return request, it translates this request and routes the call to the last caller.

Configuring a Last Call Return Key

Mitel Web UI

1. Click on **Operation > Programmable Keys**.

Programmable Keys Configuration

Key	Type	Value	Line
1	Last Call Return		1
2	None		1
3	None		1

2. Select from **Key 1** through **Key 3**.
3. In the **Type** field, select **Last Call Return**.
4. In the **Line** field, select the line to apply this feature Valid values are **1** and **2**.
5. Click **Save Settings**.

Call Forward Key

Using the Mitel Web UI, you can configure the Call Forward function on a programmable key. Use call forwarding when you want a specific account on your phone to be forwarded to another number when your phone is in the busy state or the no answer state, or both. Pressing the **Call Fwd** key on the phone

accesses the Call Forward menus. The menus that display are dependent on the Call Forward mode (**Account** [default], **Phone**, or **Custom**) configured for the phone.

For more information about call forwarding and call forwarding modes, see [Call Forward Configuration](#).

Configuring a Call Forward

Mitel Web UI

1. Click on **Operation > Programmable Keys**

Programmable Keys Configuration

Key	Type	Value	Line
1	Call Fwd		1
2	None		1
3	None		1

2. Select from **Key 1** through **Key 3**.
3. In the **Type** field, select **Call Fwd**.
4. Click **Save Settings**.

Speeddial/Xfer

The **Speeddial** key allows a number to be dialed quickly by pressing one key configured for speed dialing. The **Transfer** key allows a call to be transferred to other recipients blindly or consultatively. The **Speeddial/Xfer** key combines the **Speed dial** and **Transfer** key's functionality together allowing the user to transfer calls or use speed dial with one key.

NOTE: It is recommended that you enable the Switch UI Focus to Ringing Line parameter when using the Speeddial/Xfer feature. For more information about this parameter, see [Switch UI Focus to Ringing Line](#).

Speeddial/Xfer Key Requirements and Functionality

The **Speed Dial/Xfer** key has the following capabilities:

- Speed Dial/Xfer and Speed Dial: When the phone is in the idle state, pressing the **Speed Dial/Xfer** key causes the phone to go offhook and dial the predefined extension.
- Speed Dial/Xfer and Blind Transfer: When the phone is connected to a call, pressing the **Speed Dial/Xfer** key blind transfers the call to the predefined target. If transferring a call fails, a message **Transfer Failed** displays, and you can reconnect the call (get the call back) by pressing the line key again.
- Speed Dial/Xfer and Call Forward: When the phone is in the ringing state, pressing the **Speed Dial/Xfer** key forwards the call to the predefined extension.

Configuring a Speeddial/Xfer Key

Mitel Web UI

1. Click on **Operation > Programmable Keys** .

Programmable Keys Configuration

Key	Type	Value	Line
1	Speeddial/Xfer	5551212	1
2	None		1
3	None		1

2. Select from **Key 1** through **Key 3** .
3. In the **Type** field, select **Speeddial/Xfer**.
4. In the **Value** field, enter the speed dial extension or the extension to transfer calls to (for example, **5551212**).
5. In the **Line** field, select the line for which you want to use the key functionality.
6. Click **Save Settings**.

Speeddial/Conf

The 6905 allows you to configure a programmable key to be used as a speed dial conference key (**Speeddial/Conf** key) while remaining in the current call. This key allows a user on a call to conference another party at a predefined number while remaining in the call.

For example, while on an active call, a user can use the **Speeddial/Conf** key to dial a recording service and have the resulting conference recorded.

NOTE: If currently in a conference, the **Speeddial/Conf** key is disabled on the active call.

If you configure a programmable key as a **Speeddial/Conf** key and you press this key while on an active call, the focused line changes to the dialing line. The active call is not put on hold when the speed dial number is dialed.

NOTE: This feature is not compatible with centralized conferencing.

Configuring a Speeddial/Conf Key

Mitel Web UI

1. Click on **Operation > Programmable Keys**.

Programmable Keys Configuration

Key	Type	Value	Line
1	Speeddial/Conf	5551212	1
2	None		1
3	None		1

2. Select from **Key 1** through **Key 3**.
3. In the **Type** field, select **Speeddial/Conf**.
4. In the **Value** field, enter the number or the extension to add to the conference (for example, **5551212**).
5. In the **Line** field, select the line for which you want to use the key functionality.
6. Click **Save Settings**.

Directory Key

The Directory feature allows you to view Directory entries from multiple sources and store frequently used names and numbers on the phone. You can also dial directly from a Directory entry.

Using the Mitel Web UI, you can assign the **Directory** function to any programmable key.

NOTE: For more information about the Directory, see [“Directory”](#).

Configuring a Directory Key

Mitel Web UI

1. Click on **Operation > Programmable Keys**.

Programmable Keys Configuration

Key	Type	Value	Line
1	Directory		1
2	None		1
3	None		1

2. Select from **Key 1** through **Key 3**.
3. In the **Type** field, select **Directory**.
4. Click **Save Settings**.

Callers List Key

By default, the **Callers List** key is programmed on Key 1. However, using the Mitel Web UI, you can reassign the **Callers List** key to any of the three programmable keys on the phone.

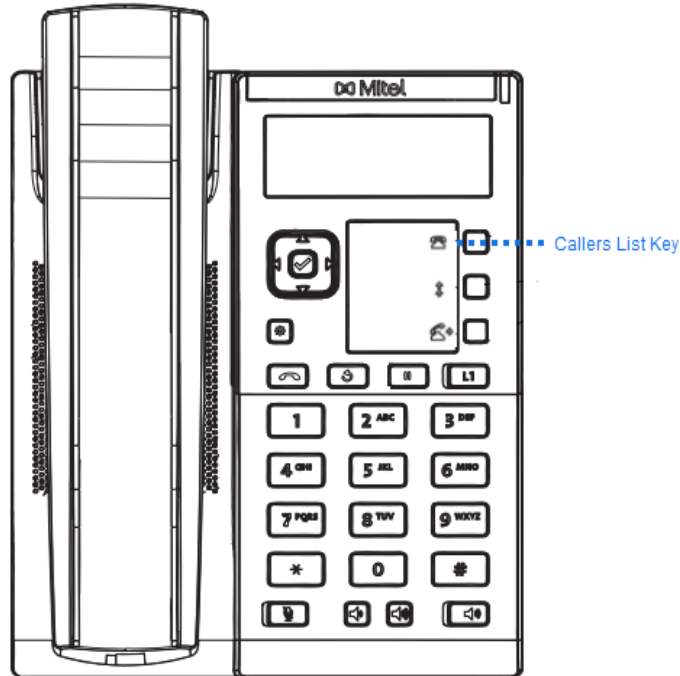

The Callers List is a stored log of your incoming calls. You can use the Callers List key to access a list of callers that called your phone .

NOTE: For more information about the Callers List, see [“Callers List”](#).

Configuring a Callers List Key

Mitel Web UI

1. Click on **Operation > Programmable Keys** .

Programmable Keys Configuration

Key	Type	Value	Line
1	Callers List		1
2	None		1
3	None		1

2. Select from **Key 1** through **Key 3**.
3. In the **Type** field, select **Callers List**.
4. Click **Save Settings**.

Redial Key

1. To redial the last number that you manually dialed, pick up the handset (optional).
2. Press .

By default, the **Redial** key is programmed on Key 2. However, using the Mitel Web UI, you can reassign the **Redial** key to any of the three programmable keys on the phone.

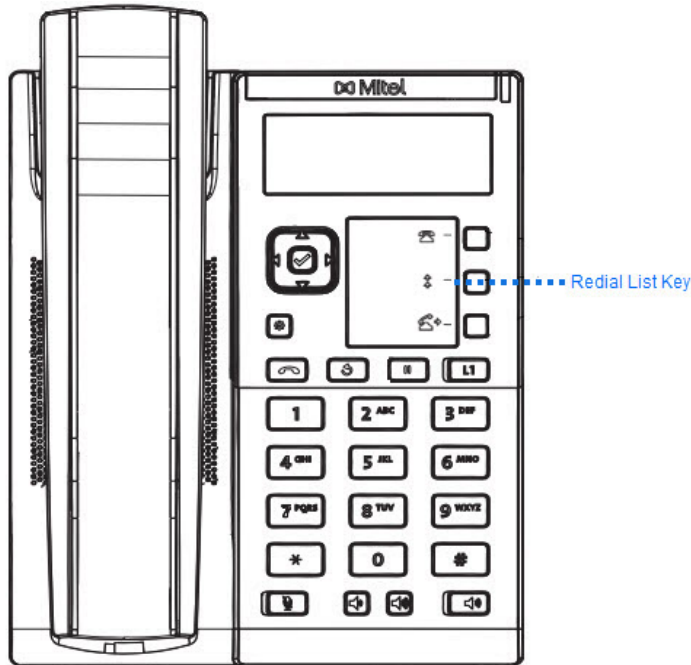

The Redial List is a stored log of your outgoing calls. You can use the Redial key to access a list of the most recent calls you placed.

NOTE: For more information about the Redial functionality, see [Redial](#)

Configuring a Redial Key

Mitel Web UI

1. Click on **Operation > Programmable Keys**.

Programmable Keys Configuration

Key	Type	Value	Line
1	Redial		1
2	None		1
3	None		1

2. Select from **Key 1** through **Key 3**.

3. In the **Type** field, select **Redial**.
4. Click **Save Settings**.

Conference Key

The 6905 IP phone offers two methods of conferencing:

- Local conferencing (default method)
- Centralized conferencing (for Sylanro and BroadSoft Call managers)

The Conference key allows you to create conference calls when utilizing any one of the method above.

NOTE: For more information with regards to creating conference calls, see [“Conferencing Calls”](#)

Configuring a Conference Key

Mitel Web UI

1. Click on **Operation > Programmable Keys**.

Programmable Keys Configuration

Key	Type	Value	Line
1	Conference		1
2	None		1
3	None		1

2. Select from **Key 1** through **Key 3**.
3. In the **Type** field, select **Conference**.
4. Click **Save Settings**.

Transfer Key

By default, the **Transfer** key is programmed on Key 3. However, using the Mitel Web UI, you can reassign the **Transfer** key to any of the three programmable keys on the phone

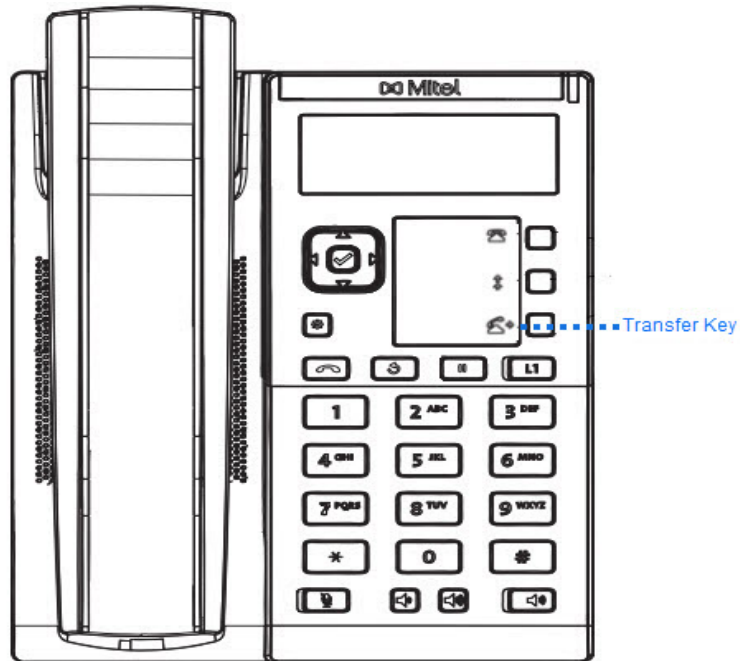

NOTE: For more information about transferring calls, see [Transferring Calls](#) .

Configuring a Transfer Key

Mitel Web UI

1. Click on **Operation > Programmable Keys** .

Programmable Keys Configuration

Key	Type	Value	Line
1	Transfer		1
2	None		1
3	None		1

2. Select from **Key 1** through **Key 3**.
3. In the **Type** field, select **Transfer** .
4. Click **Save Settings** .

Intercom Key

By default, the IP phone allows incoming intercom calls to be automatically answered without having to set up an **lcom** key on your phone.

NOTE: For more information about changing the behavior of incoming Intercom calls, see the section [“Incoming Intercom Call Features”](#).

Your System Administrator can enable outgoing intercom calls on your phone. If enabled, you must configure an Icom key on your phone to use for outgoing intercom calls. You must configure a programmable key with the function, **Icom**.

Configuring an Intercom Key

Mitel Web UI

1. Click on **Operation > Programmable Keys**.

Programmable Keys Configuration

Key	Type	Value	Line
1	Icom		1
2	None		1
3	None		1



2. Select from **Key 1** through **Key 3**.
3. In the **Type** field, select **Icom**.
4. In the Value field, enter the predefined number you wish to be dialed when the Intercom key is pressed.

NOTE: If no value is defined, you will need to manually enter a number after pressing the Intercom key.

5. Click **Save Settings**.

Using the Icom Key

IP Phone UI

1. Press the **Icom** key.
2. If no number was defined when configuring the key, enter the extension number of the person you want to intercom.
3. After a beep tone, your phone automatically connects with the remote extension and you can speak through its speaker.
4. To cancel intercom, press  or hang up the handset.
5. When you are finished speaking, hang up the phone by placing the handset back on-hook or by pressing . When you hang up, the remote phone also hangs up.

Services Key

The 6905 allows you to configure a **Services** key that, when pressed displays the Services Menu. The Services Menu can also be accessed through the Options List.

The **Services** key can also access any XML applications setup by your System Administrator. Contact your System Administrator for more information.

Configuring a Services Key

Mitel Web UI

1. Click on **Operation > Programmable Keys**.



Programmable Keys Configuration

Key	Type	Value	Line
1	Services		1
2	None		1
3	None		1

2. Select from **Key 1** through **Key 3**.
3. In the **Type** field, select **Services**.
4. Click **Save Settings**.

Using the Services Key

IP Phone UI

1. Press the **Services** key or press  and select **Services**.
NOTE: Additional options may display in the Services Menu if setup by your System Administrator. Contact your Administrator for more information.
2. Select an option from the Services Menu.
3. To cancel a Service, press .

Phone Lock Key

You can configure a programmable key on the phone to use as a lock/unlock key. You assign the function of the key as **Phone Lock**.

Configuring a Phone Lock Key

Mitel Web UI

1. Click on **Operation > Programmable Keys**.

Programmable Keys Configuration

Key	Type	Value	Line
1	Phone Lock		1
2	None		1
3	None		1

2. Select from **Key 1** through **Key 3**.
3. In the **Type** field, select **Phone Lock**.
4. Click **Save Settings**.

NOTE: You can lock/unlock the phone using the new key you just configured, using the Mitel Web UI at the path **Operation > Phone Lock**, or using the Phone Lock option on the IP phone UI at the path **Options > Phone Lock**. For more information about using the lock/unlock feature, see [Locking/Unlocking a Phone](#).

Paging Key

You can configure a **Paging** key on the phone that allows you to send a Real Time Transport Protocol (RTP) stream to pre-configured multicast address(es) without involving SIP signaling. You enter a multicast IP address(es) and a port number for the Paging key, that when pressed, initiates an outgoing multicast RTP session. This is called Group Paging on the IP phones.

You can also specify group paging RTP addresses that the phone listens for when receiving RTP streams. You can specify up to 5 listening multicast addresses at the path, *Basic Settings > Preferences > Group Paging RTP Settings*.

For more information about Group Paging and how it works, and to specify multicast addresses, see [Group RTP Paging](#).

Configuring a Paging Key

Mitel Web UI

1. Click on **Operation > Programmable Keys**.

Programmable Keys Configuration

Key	Type	Value	Line
1	Paging	239.0.1.15:10000	1
2	None		1
3	None		1

2. Select from **Key 1** through **Key 3**.
3. In the **Type** field, select **Paging**.
4. In the **Value** field, enter a multicast IP address and a port number for the Paging key. When you press this key, the phone initiates an outgoing multicast RTP session to the specified address using the specified port (e.g. 239.0.1.15:10000).

NOTE: The Value field allows for one multicast address entry only.
5. To receive RTP steams for Group Paging, you must also configure the **Paging Listen Addresses** parameter at the path, **Basic Settings > Preferences > Group Paging RTP Settings** . For more information about setting this parameter, see [Group RTP Paging](#) .
6. Click **Save Settings**.

Using the Paging Key

The following procedure describes the use of the **Paging** key on the IP phone. The procedure assumes you have already configured the **Paging** key using the Mitel Web UI.

NOTE:

1. The recipient of a Paging call can set a global Do Not Disturb (DND) to ignore any incoming pages.
2. For incoming Paging, the phone uses the Intercom configuration settings. The incoming Page is dependent on the Allow Barge In parameter setting and the Idling/On Call state. This option is only available if external Directory sources have been configured by your Administrator.

IP Phone UI

1. On the IP phone, press the key you configured for Paging.
2. The phone opens a multicast RTP session and an outgoing OR incoming phone screen displays.
3. Press the **Drop** key to end the multicast RTP session and return to the idle screen.

NOTE: If you enable global DND on the phone, the incoming multicast RTP session is dropped.

Save Key

The **Save** key allows you to save items to the 6905 IP phone's Local Directory. Use the following procedure to configure a key as a **Save** key in the Mitel Web UI.

Configuring a Save Key

Mitel Web UI

1. Click on **Operation > Programmable Keys**.

Programmable Keys Configuration

Key	Type	Value	Line
1	Save		1
2	None		1
3	None		1

2. Select from **Key 1** through **Key 3**.
3. In the **Type** field, select **Save**.
4. Click **Save Settings**.

Delete Key

The **Delete** key allows you to delete items in the Local Directory, Callers List and Redial List. Use the following procedure to configure a key as a **Delete** key in the Mitel Web UI.

Configuring a Delete Key

Mitel Web UI

1. Click on **Operation > Programmable Keys**.

Programmable Keys Configuration

Key	Type	Value	Line
1	Delete		1
2	None		1
3	None		1

2. Select from **Key 1** through **Key 3**.
3. In the **Type** field, select **Delete**.
4. Click **Save Settings**.

None Key

Use the following procedure to delete a key's functionality on the 6905 IP phone

Setting a None Key

Mitel Web UI

1. Click on **Operation > Programmable Keys**.

Programmable Keys Configuration

Key	Type	Value	Line
1	None		1
2	None		1
3	None		1

2. Select from **Key 1** through **Key 3**.
3. In the **Type** field, select **None**.
4. Click **Save Settings**. The key function is deleted from the IP phone memory.

Discreet Ringing Key

You can configure a **Discreet Ringing** key on the phone that when pressed allows you to toggle on/off the Discreet Ringing feature. When the Discreet Ringing feature is enabled, if a call is incoming, the phone will play the configured ring tone once only. All applicable visual indicators (LED for the corresponding Line key, Message Waiting Indicator [MWI], etc...) will behave normally.

NOTE: If a custom ring tone is selected and Discreet Ringing is enabled, the phone will not play the custom ring tone during an incoming call. Ring tone 1 will be played once instead.

Configuring a Discreet Ringing Key

Mitel Web UI

1. Click on **Operation > Programmable Keys**.

Programmable Keys Configuration

Key	Type	Value	Line
1	Discreet Ringing		global
2	None		global
3	None		global

2. Select from **Key 1** through **Key 3**.
3. In the **Type** field, select **Discreet Ringing**.
4. Click **Save Settings**.

Making Calls

This section describes ways to make calls on your 6905 phone, using your handset or speakerphone.

Dialing a Number

First, take the phone off-hook by:

- Lifting the handset
- Pressing  or
- Pressing a line/call appearance key.

At the dial tone, enter the number you wish to call.

NOTE: After dialing the number, the phone has a short delay before sending the call. To send the call immediately, you can press the 4 **Dial** key immediately after dialing the number. The phone sends the call without delay.

If you are unable to make calls within certain area codes, check with your System Administrator for any toll restrictions placed on your extension that may restrict your access to long distance area codes or dialing prefixes.







When your party picks up, a timer appears on your display that records the length of your call.

If the **Live Dialpad** option is on, as soon as you press the first digit on the keypad the phone automatically selects the next available line, go off-hook and dial as digits are pressed.

Using Handsfree Speakerphone

The handsfree feature allows you to speak to someone without using the handset. Your phone must be in the **Speaker** mode.

IP Phone UI

- To dial using hands free, first press  and enter a number at the dial tone.
- To answer a call on your phone using handsfree, press  or the line/call appearance key.
- If you are in Speaker mode, lift the handset and press  to switch between handsfree and handset.
- When the handset is on hook, press  to disconnect the call.

NOTE: When handsfree is on, the speaker light turns on.

USING A HEADSET

The 6905 SIP Phone accepts analog headsets through the handset jack RJ11 located on the back of the phone. Contact your telephone equipment retailer or distributor to purchase a compatible headset.



NOTE: Customers should read and observe all safety recommendations contained in headset operating guides when using any headset.

MAKING AND RECEIVING CALLS USING A HEADSET

1. Turn the phone over and locate the handset jack marked .

Insert the headset cord into the jack until it clicks into place.

NOTE: See the **Mitel 6905 SIP IP Phone Installation Guide** for more information.

2. Press the  key to obtain a dial tone or to answer an incoming call.
3. Press the  key to end the call.

Redial

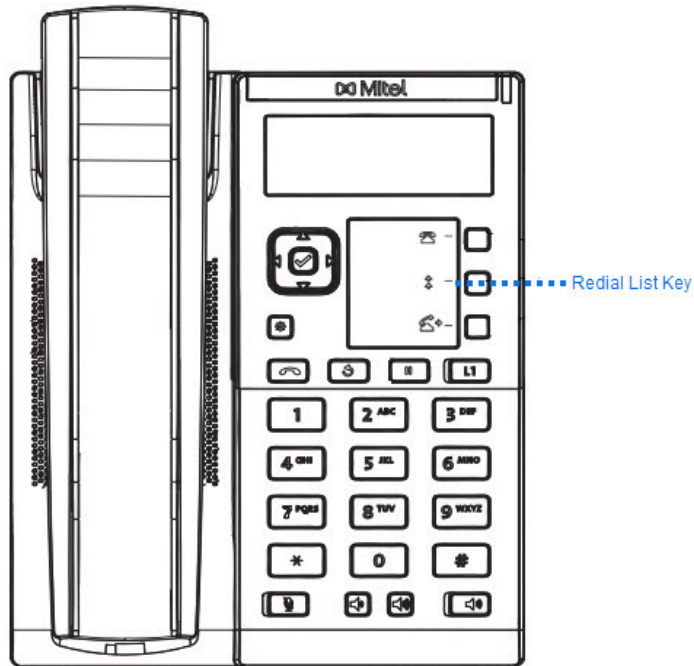

NOTE: Redial List information in this User Guide describes the phone's native Redial List. In some environments, the Redial List key may bring up a Redial List provided by the call manager; therefore, depending on your call manager, the Redial List on your phone may function and behave differently than what is documented in this User Guide. If this is the case, contact your System Administrator for more information regarding your specific Redial List.

The Redial List stores information for up to the last 100 numbers you called. Your phone logs the name/number of the called party, when you called, and the line used. You can view, scroll, and delete line items in the Redial List from the IP phone UI as well as copy selected entries to the Local Directory. You can also dial out directly using a displayed entry in the Redial List.



Accessing the Redial List

IP Phone UI

1. Press the **Redial** hard key or configured **Redial** key to access the Redial List. The information for your most recent call is displayed.
NOTE: To redial the last called number, press the Redial key again.
2. Use ▲ and ▼ to scroll through the list to view the other numbers.
3. To dial the displayed number press , or lift the handset, or press any line keys.
4. Press the  key to cancel.

Deleting An Item from the Redial List

IP Phone UI

1. Press the **Redial** hard key or configured **Redial** key.
2. Press ▲ and ▼ to find the item you want to delete.
3. Press the configured **Delete** Key.

```
DELETE again to
erase this item
▶Delete All
```

4. Press the **Delete** Key again at the prompt to erase the item.

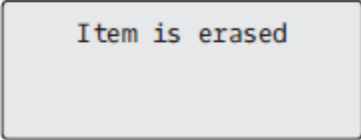

Item is erased

IP Phone UI

Delete All Items

1. Press the **Redial** hard key or configured **Redial** key.
2. Press the configured **Delete** key.

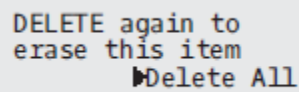



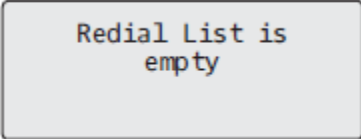

DELETE again to
erase this item
▶Delete All

3. Press the ▶ **Delete All** key at the prompt to erase all items from the Redial List.



Redial List is
empty

Mute

You can use the  key to mute the handset or speakerphone. When you use  the key on your phone, you cannot be heard on an active call or on a conference. For muted calls, the handsfree LED flashes and the  key LED is on. To switch mute on or off, press . **NOTE:** *If you place a muted call on hold, the phone automatically takes the call off mute when you reconnect to the call.*

Receiving Calls

When a call is ringing at your extension, you see the inbound call screen. The line/call appearance LED flashes quickly for the incoming call.



Answering an Incoming Call

IP Phone UI

1. For hands free operation, press  or the line/call appearance key for the incoming call.
or
Lift the handset for handset operation.

If the phone is already connected to a call, pressing the line/call appearance key for the new incoming call automatically places the connected call on hold and answers the new call. To reconnect to a party, press the line/call appearance key for that call.

If you cannot answer the call, the caller goes to voicemail (if configured for your extension).

NOTE: The  key can be used to cancel the call pickup procedure.

Deflecting an Incoming Call

While call forwarding allows you to forward calls to a pre-defined number, and whereby most call transfers requires you to first answer the incoming call, call deflection allows you to manually determine, while a call is incoming, what the destination number should be.

You can enter a destination number using the dialpad keys or deflect a call quickly to a programmable key configured with Speeddial functionality. Applicable key types include:

- Speeddial
- Speeddial/Xfer
- Speeddial/Conf



NOTE:

1. Live dialpad is disabled when entering destination numbers using the call deflection feature.
2. When the "No Answer" Call Forward mode is configured and enabled on the phone, incoming calls will not be forwarded to the defined "No Answer" number if you are in the process of deflecting the incoming call.



For example, during an incoming call, with the "No Answer" Call Forward mode configured to forward incoming calls after five rings, if you press the Transfer key and in the process of deflecting the call five rings elapse, the call will not be forwarded. This is true even if you decide not to deflect the call

and cancel the deflection process after five rings. However, if you cancel the deflection process before five rings, the call will be forwarded per usual.

IP Phone UI

1. During an incoming call, press  the key or programmable key configured with Transfer functionality.
2. Using the dialpad keys, enter the destination number to which you wish to deflect the incoming call
or
Press a programmable key configured with Speeddial functionality.
3. If a destination number was entered manually, press  the key, programmable key configured with Transfer functionality, or 4 navigation key to deflect the call.

Sending an Incoming Call to Voicemail

You can send an incoming call directly to voicemail without answering the call. To do this, press  without picking up the handset. If you are already on the phone your incoming call should go directly to voicemail. Your phone screen displays a voicemail icon () along with the number of waiting messages, if you have unheard messages (example:  x4).

Handling Calls

When you are connected to a call, you can use the hard keys to place a call on hold, and programmable keys to transfer calls or create conference calls.

Placing a Call on Hold

You can place an active call on hold by pressing the Hold  key. When you place a call on hold, only your phone can retrieve the call. When a call is on hold, the icon displays on-hook as follows.

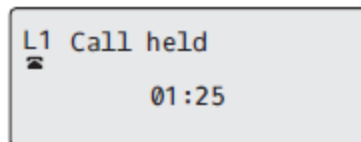

For on-hold calls, the timer displays as running and the Line and Message Waiting Indicator (MWI) LEDs flash.

IP Phone UI

1. Connect to the call (if not already connected).
2. Press the  key.

The line/call appearance light begins to flash slowly and after a short time the phone beeps softly to remind you that you still have a call on hold. The screen displays **Call held** with the line number the call is held at the phone.

NOTE: If you are connected to another call, the phone does not beep to remind you that you still have a call on hold.



When on Hold





To let your caller know that they are still on hold, music plays softly (if this has been set up for your system). The call/line appearance light for the line you are on flashes to indicate that you are still connected.



NOTE: On Mitel 6905 SIP phone, LED next to the Hold hard key does not flash as there is no LED next to hold key as per Hardware Design.



Automatic Hold

When juggling between calls, you do not have to press the  key to go from one call to the next. The phone automatically puts your current call on hold as soon as you press a new line/call appearance key. If you have more than one call on hold, you can reconnect to a held call by pressing the line/call appearance key where that call is being held. Press  to disconnect the call.

Retrieving a Held Call

If you have more than 1 call on hold, you can scroll through the held call information by pressing  and  navigation keys. To reconnect to a call press the line/call appearance key where that call is being held. If you press the call/line appearance key again, you disconnect from the call.

If an attempt to retrieve a held call fails, the 6905 displays a "Server Error" message and error reason code on screen (e.g. "Server Error: 408" for a Request Timeout or "Server Error: 503" for a Service Unavailable). You can disconnect the call on hold by pressing the  key in certain circumstances. A call on hold can be disconnected by pressing the  key only when these three conditions are met:

- The line with the call on hold is the line in focus.
- You have attempted to retrieve the call on hold by pressing the line/call appearance key where that call is being held and the  key.
- The attempt to retrieve the call on hold failed due to a 408, 5xx, or 6xx reason code. If the attempt failed due to a different server error reason, pressing the  key will not disconnect the call.

This behavior is applicable to all call-on-hold scenarios such as single point-to-point calls, conference calls, and any transfer scenarios. In an attended transfer scenario, pressing the  key after a failed retrieval attempt (that meets the above three conditions) will disconnect the call on hold instead of launching the transfer.

Transferring Calls

By default, the **Transfer** key is preprogrammed on Key 3 of the 6905 IP phone. You can use this programmable key to transfer calls.

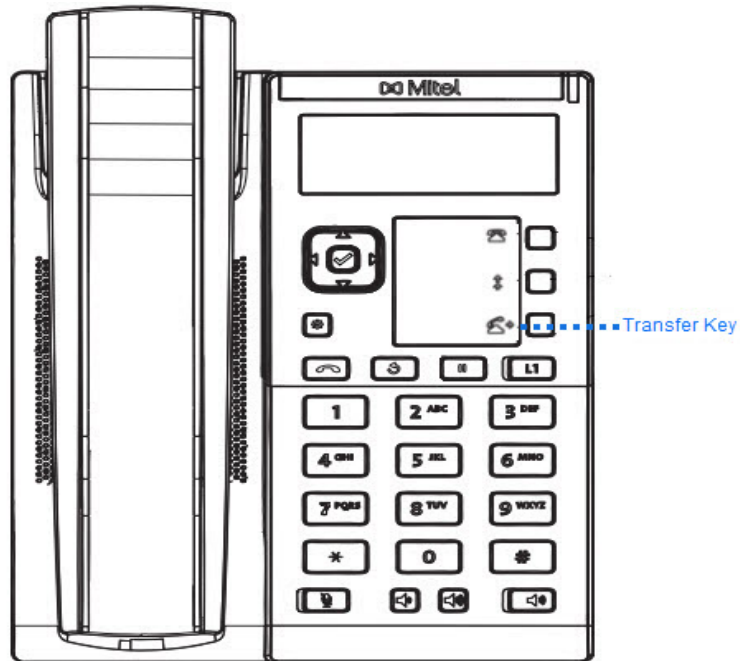

Blind Transfer

A blind transfer is when you transfer a call directly to another extension without consulting with the person receiving the call. To do this, simply complete the transfer immediately after you have entered the number. The call goes directly to the extension or outside line you transferred to. If the party you are transferring the call to does not answer, the transferred call rings back to your extension.

Consultative Transfer

You also have the option to consult with the person you are transferring the call to, before you complete the transfer. To do this, remain on the line until the receiving party answers the call. After consulting with the receiving party, you can either complete the transfer or cancel the transfer to go back to the original call.

Direct Transfer

The 6905 IP phone provides a convenient direct method of transferring an existing call to another existing call. If you have the transfer recipient on hold on another line, you can simply navigate to the recipient and press the **Transfer** key and the direct transfer will be performed.

Transferring Calls

Use the following procedure to transfer a call to another extension.

IP Phone UI



1. Connect to Party 1 (if not already connected). Party 1 is the party you want to transfer.
2. Press the programmed **Transfer** key.

3. Enter the extension number (or the outside number) to Party 2. This is the Party for which you want to transfer Party 1.



To cancel the transfer press the  key, or hang up the handset.

4.

NOTE: Users are able to edit the destination number by pressing the 3 navigation key, which acts as a Backspace key.

5. Complete either a blind or consultative transfer:
 - a. To complete a blind transfer, press the programmed **Transfer** key again before the receiving end answers.
 - b. To complete a consultative transfer, press  Dial to dial out and remain on the line to speak with the Party 2, before either pressing the programmed **Transfer** key or  key, or hanging up the handset to transfer Party 1 to Party 2.

Transferring an Existing Call to Another Existing Call



1. Ensure you are on an active call with the party you wish to transfer (the transfer recipient should be placed on hold).
2. Press the  and  navigation keys to scroll to the party to whom you wish to transfer the active call.
3. Press programmed **Transfer** key.
4. The active call will be transferred.

Completing a Transfer to a Contact in Phone Directory

Users can complete a blind transfer to a contact in their directory. If a user is in a call and initiates a transfer, they can navigate to the Directory screen and press the Transfer key again to trigger a blind transfer. There is no change to start a consultative call.

To Transfer a Call to a Contact in the Phone Directory:

1. Connect to Party 1 (if not already connected). Party 1 is the party you want to transfer.
2. Press the programmed **Transfer** key.
3. Press the programmed **Directory** key and select a contact.
4. To complete a blind transfer, press the programmed **Transfer** key again before the receiving end answers.

To complete a consultative transfer, press  **Dial** to call the contact. Remain on the line to speak with Party 2 before pressing the programmed **Transfer** key again to transfer Party 1 to Party 2. To cancel the transfer, press the  key.

5.

Indication of Transferred Calls

When you transfer an active call, the near-end phone displays a Call Transferred screen when a call is transferred and the far-end call is dropped. The following is the Call Transferred screen on the 6905 phone:

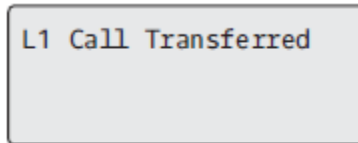

Conferencing Calls

The 6905 IP phone offers two methods of conferencing:

- Local conferencing (default method).
- Centralized conferencing (for Sylanro and BroadSoft call managers - Administrator must enable this method).

NOTE: Mitel 6905 SIP phone does not support blind conference on the MiVoice Connect Platform.

Local Conferencing

The 6905 phone supports up to 3 parties (including yourself) in a conference call. This is called Local Conferencing and is the default method of conferencing on the 6905.

NOTE: Your System Administrator can set your **Conference** key to speed dial a specific number. Contact your System Administrator for more information.

The following screen illustrates

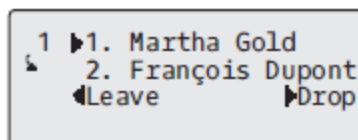

a connected local conference screen:

In a local conference call, you use the up and down arrow keys to scroll to a party on the list, the 4 **Drop** key to drop a selected party and the 3 **Leave** key to leave the conference.

Using Local Conferencing

Use the following procedure to create a conference call using local conferencing.

IP Phone UI

1. When you begin a conference, you are the first party in the conference (Party 1). Pickup the handset or press the  key. A line opens up.
2. Call Party 2 by dialing their number (or answer an incoming call of a Party).
3. Wait for Party 2 to answer. When Party 2 answers, you can consult with them before adding them to the conference.

- Press the programmed **Conference** key.

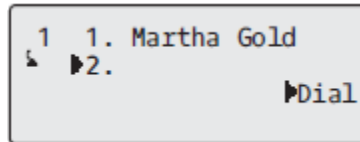

- Enter the phone number of Party 3.

NOTE: Users are able to edit the destination number by pressing the 3 navigation key, which acts as a Backspace key.

- Wait for Party 3 to answer. When Party 3 answers, you can consult with them before adding them to the conference.

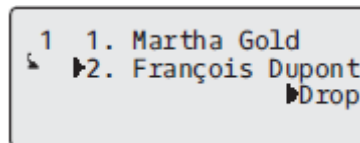

- Press the programmed **Conference** key again to add Party 3 to the conference. Party 1 (which is yourself), Party 2, and Party 3 are all connected to a single conference.

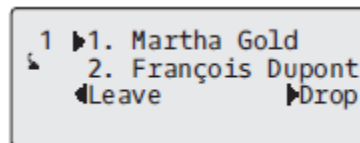

- To drop a party from the conference, use the ▲ and ▼ navigation key to select the party and press the ► **Drop** key.

Creating a Conference Call by Joining Two Existing Calls

IP Phone UI

- Ensure you are on an active call with one of the parties with whom you wish to create a conference (the other party should be placed on hold).
- Press the ◀ and ▶ navigation keys to scroll to the party you wish to conference in.
- Press the programmed **Conference** key. The two parties will connect with you to form a conference call.

Centralized Conferencing (for Sylantrö and BroadSoft Call Managers)

The 6905 allows you to create multiple conferences with unlimited participants (depending on your server limitations) when your Administrator enables Centralized Conferencing.

If your Administrator does not enable Centralized Conferencing, then the 6905 uses Local Conferencing by default.

Your Administrator can configure Centralized Conferencing globally on all lines or on specific lines. Although, for the global setting to work, you must configure the lines with the applicable phone number.

Using Centralized Conferencing

IP Phone UI

NOTE: When Centralized Conferencing is enabled on your phone, local conferencing (or three-way conferencing) works as indicated in the previous section, [“Using Local Conferencing”](#) Joining two active calls in a conference also works as indicated in the previous section, [“Creating a Conference Call by Joining Two Existing Calls”](#).

Use the following procedure to create a conference call using centralized conferencing.

Setting Up a Conference and Adding Multiple Parties (for Sylanro and BroadSoft Call Managers)

NOTE: You can have an unlimited number of parties in a conference (dependent on the limitations of the server).

1. When you begin a conference, you are the first party in the conference (Party 1). Pickup the handset or press the  key.
2. Call Party 2 by dialing their number (or answer an incoming call of a Party).
3. Wait for Party 2 to answer. When Party 2 answers, you can consult with them before adding them to Conference 1.
4. Press the programmed **Conference** key.
5. Enter the phone number of Party 3.
6. Wait for Party 3 to answer. When Party 3 answers, you can consult with them before adding them to the Conference 1.
7. Press the programmed **Conference** key again to add Party 3 to Conference 1. Party 1 (which is yourself), Party 2, and Party 3 are all connected to Conference 1.
8. Press an available **Line** key (or answer an incoming call on an available line). If calling out, call Party 4.
9. Wait for Party 4 to answer. When Party 4 answers, you can consult with them before adding them to the conference.
10. Press the programmed **Conference** key to add Party 4 to Conference 1.
11. Press the **Line** key that has Conference 1.
12. Press the programmed **Conference** key to join all parties (Parties 1 through 4) on Conference 1.
13. To add more parties, repeat steps 8 through 12.

If any party in the conference hangs up (including the party that began the conference), all other parties in the conference are still connected.

Setting Up Multiple Conferences (for Sylanro Call Manager only)

NOTE: The 6905 is limited to 2 conferences (a single conference each on lines 1 and 2).

1. Start Conference 1 using the procedures in the previous section, [“Setting Up a Conference and Adding Multiple Parties \(for Sylanro and BroadSoft Call Managers\)”](#).
2. When you are finished adding all required parties to Conference 1, press an available **Line** key to start Conference 2. You are Party 1 on Conference 2. Call Party 2.
3. When Party 2 answers, press the programmed **Conference** key.
4. Press an available **Line** key.

5. Call Party 3 for Conference 2.
6. When Party 3 answers, press the programmed **Conference** key to join Parties 1 (which is yourself), Party 2, and Party 3 on Conference 2. You now have two active conferences on two different lines.

NOTE: When you are connected to multiple conference calls, and you put a conference on hold, the conference may be on hold for a limited period of time before it is disconnected. Contact your System Administrator for more information.

If any party in a conference hangs up (including the party that began the conference), all other parties in the conference are still connected.

Joining Additional Parties to Active Conferences

In centralized conferencing, you can join multiple incoming or outgoing calls to active conferences. Before following this procedure, at least one active conference must exist on your phone.

1. As Party 1, pickup the handset or press the  key.
2. Call Party 2 by dialing their number (or answer an incoming call of a Party).
3. Wait for Party 2 to answer. When Party 2 answers, you can consult with them before adding them to the conference.
4. Press the programmed **Conference** key.
5. Press the **Line** key that has the active conference.
6. Press the programmed **Conference** key again to join the parties to the active conference.

Ending a Conference and Transferring Remaining Parties

The 6905 allows a host to drop from a 3-way conference and let the other two parties remain connected. If you are the host of a conference and want to leave that conference press the 3 **Leave** key on the phone. Your phone leaves the 3-way conference but the remaining parties are still connected to the conference.

NOTE: The Caller ID of the dropped host still displays on the remaining parties' phones.

Ending Calls

IP Phone UI

To end a call, you first need to connect or reconnect to the call if not already connected (for example, if your caller is on hold). Press  to end the call. If connected through the handset, you can also place the handset back on hook to end the call.

Managing Calls

The 6905 has several features that make it easier to manage calls, and to keep track of your caller history as well as your business and personal contacts.

These features include:

- Directory
- Callers List
- DND and Call Forward

Directory



The Directory is your personal phone book, conveniently stored within your phone. The 6905 IP phone supports enhanced Directory functionality allowing for interoperability with multiple directory sources (i.e. Local Directory, Corporate and Personal CSV directories, LDAP, Microsoft Exchange, Xsi Enterprise Directory, Xsi Personal Contacts, Xsi Enterprise Common Phone List, Xsi Group Directory, and Xsi Group Common Phone List).

NOTE: For information on how to configure a **Directory** key, see [Directory Key](#).

General Directory Functions

IP Phone UI

Accessing and Navigating the Directory

1. Press the programmed **Directory** key.
2. You can view the various Directory sources by pressing ▲ and ▼ to scroll through the list.
3. Press ► **Enter** to enter a Directory source and press ▲ and ▼ to scroll through the list of contacts.
4. To dial the displayed number press  or just lift the handset or press any **Line** key.
5. Press the programmed **Directory** key or  key to cancel.

Performing a Search

Search functionality is applied across all the available and enabled directories. After entering the Search menu, inputting the first few letters of the contact's name, and then pressing 2 Search, you can quickly select a contact and perform the desired action.

IP Phone UI

1. Press the configured Directory key or press  on the phone to enter the Options List and navigate to the **Services > Directory** menu.

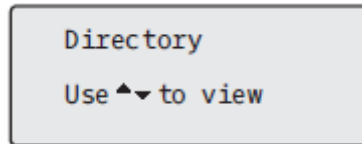

2. Press the ▲ key to view the **All** folder and press the ► **Search** key.
3. Use the dialpad keys to enter the name (first, last, full, or partial) of the entry you are searching for and press the ▲ **Search** key.

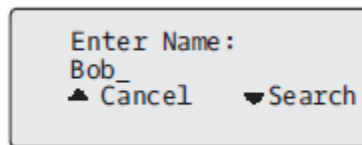

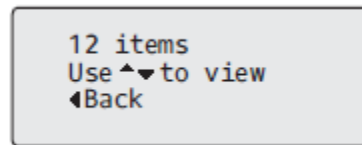

A screen displays detailing the number of search hits.



NOTE: If there are no hits, a "No Matches Found" message is displayed.

4. Press the ▲ and ▼ keys to view the entries in the consolidated search list.

NOTE:

- a. To place a call to the entry, press the  button, Line button,  button, or simply pick up the handset.
- b. To copy the entry to the Local Directory (if the entry is from an external Directory source), press the **# Copy** key.
- c. To edit the entry's details (if the entry is from the Local Directory), press the **# Edit** key.
- d. Press the  key at any time to exit.

Local Directory Features

The internal Local Directory contains the contacts that have been created or copied directly to the phone using the phone UI. If no external directory sources are available, pressing on the Directory key will open the Local Directory menu.

WARNING: If you plan on upgrading at any time in the future and would like to retain your Local Directory information, it is recommended to save your Local Directory entries before any upgrade or downgrade by using the phone's Web UI under the *Operation > Directory* menu See [“Downloading the Directory to Your PC”](#) for details.

From the Local Directory menu, you can search for a contact, place a call to the selected contact, add new contacts to the Local Directory, delete all contacts, delete individual contacts, or edit existing contacts.

NOTE:

- Up to 1000 Directory contacts can be stored locally on the phone.

You can also assign an individual contact ring tone to contacts in your Local Directory. Individual contact ring tones can be used during incoming calls to help you identify the party calling. You can select contact-specific ring tones (from the phone's 15 preloaded as well as the 8 custom ring tones) for respective contacts in your Local Directory, which will be played back when a call from the respective contact is incoming.

Individual contact ring tone support is dependent on the phone's directory lookup functionality. During an incoming call, the Local Directory is examined against the phone number of the incoming call. If a match is found and the contact has an associated contact ring tone, the contact ring tone is played. If a match is not found or if a contact ringtone is not assigned, the standard ring tone for the line being used to field the incoming call is played.

NOTE:

1. In instances where a custom ring tone is selected as the individual contact ring tone for a Local Directory contact and subsequently the custom ring tone is deleted, the standard ring tone will be played.
2. Individual contact ring tone support is applicable to the Local Directory only. If you would like to apply a ring tone for a contact in an external directory source (e.g. CSV-based directories, Exchange Contacts, LDAP, and Xsi directories) or Callers List/Redial List, you must first copy the desired contact to the Local Directory.

Using the IP phone UI you can perform the following actions with regards to the Local Directory:

- Add new contacts to the Local Directory
- Edit entries in the Local Directory
- Delete all entries from the Local Directory
- Delete individual entries from the Local Directory

Adding New Entries to the Local Directory

IP Phone UI

1. Press the programmed **Directory** key.
2. Use the **▲** key to navigate to the Local Directory folder and select **▶ Enter** (or simply **▶ Add New** if the Local Directory is empty).
3. Select **▶ Add New**.
4. Using the dialpad keys, enter in a phone number and select **▲ Next**.
5. Using the **◀ and ▶** keys, select a line associated with the first phone number and press **▲ Next**.
6. Using the **◀ and ▶** keys, select a label associated with the first number (i.e. Work 1, Work 2, Mobile, Home 1, Home 2, Other, and Business Fax) and press **▲ Next**.

7. Repeat Steps 4 and 6 for any additional numbers. If you do not want to define any additional numbers, you can simply leave the number field empty and press ▲ **Next**.
8. Use the ◀ **and** ▶ navigation keys to select the desired ring tone for the respective contact and then select ▲ **Next**.
9. Using the dialpad keys, enter in the contact's first name and select ▲ **Next**.
10. Using the dialpad keys, enter in the contact's last name and select ▲ **Save**. The contact's details will be saved to your Local Directory.

Editing an Existing Local Directory Entry

IP Phone UI

1. Press the programmed **Directory** key.
2. Use the ▲ key to navigate to the Local Directory folder and select ▶ **Enter**.
3. (Optional) Using the dialpad keys input the first letter of the contact's name to initialize the search function.
4. Select # **Edit** .
5. Use the navigation keys to navigate through the various screens and edit any desired information.
6. Select ▲ **Save** to save your changes.

Deleting Entries in the Local Directory

IP Phone UI

1. Press the programmed **Directory** key.
2. Use the ▲ key to navigate to the Local Directory folder.
3. Use the ▲ **and** ▼ keys to navigate through the Local Directory contacts. If the contact has multiple phone numbers, you can select a phone number to delete by using the ◀ **and** ▶ keys to navigate to the desired phone number.
4. Press the key configured with Delete functionality.
A "DELETE to erase item or # to erase number" message is displayed on screen.
5. Press the key configured with Delete functionality again to delete the individual contact from your Local Directory or press the # key to delete the individual phone number.

IP Phone UI

DELETE ALL ENTRIES IN THE LOCAL DIRECTORY

1. Press the programmed **Directory** key.
2. Use the  key to navigate to the Local Directory folder and press the key configured with Delete functionality.
A “DELETE again to erase all items” message is displayed on screen.
3. Press the key configured with Delete functionality again to delete all contacts from your Local Directory.

Saving Entries to the Local Directory

You can save entries (names and numbers) from other sources to your Directory using any of the following methods:

- Saving from the Caller List
- Saving from the Redial List
- Saving from an external Directory Source (see [“External Directory Source Features”](#)).

Saving from the Callers List IP Phone UI

1. Press the programmed **Callers List** key.
2. From the Callers List, scroll through the list to find the contact that you want to save to your Directory.
3. Press the programmed **Save** key.
4. Press the programmed **Directory** key to save the contact you selected to the Directory.

Saving from the Redial List IP Phone UI

1. Press the programmed **Redial List** key.
2. From the Redial List, scroll through the list to find contact that you want to save to your directory.
3. Press the programmed **Save** key.
4. Press the programmed **Directory** key to save the contact you selected to the Directory.

Downloading the Directory to Your PC

You can download the Directory to your PC through the Mitel Web UI. The phone stores the *directorylist.csv* file to your PC in comma-separated value (CSV) format.

You can use any spreadsheet application to open the file for viewing. The file displays the all the relevant items for each Local Directory entry (such as first and last names, phone numbers, phone number types, corresponding line numbers, etc...)

Downloading the Directory Mitel Web UI

1. Click on **Operation > Directory**.

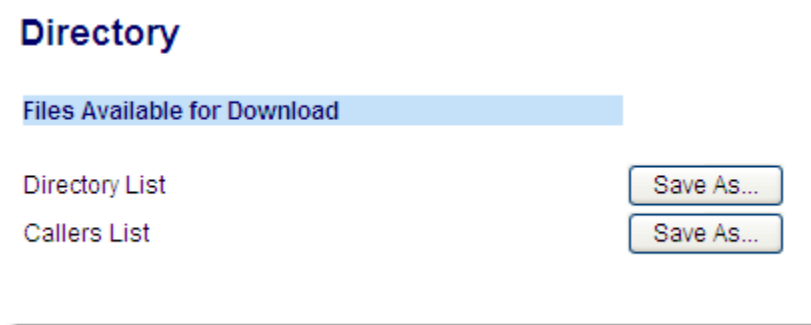

2. In the Directory field, click on **Save As**.
3. A download window displays.
4. Click **OK**.
5. Enter the location on your computer where you want to download the Directory and click **Save**.
6. The *directorylist.csv* file downloads to your computer.
7. Use a spreadsheet application to open and view the *directorylist.csv* file.

External Directory Source Features

The following external Directory sources may be configured on your phone:

- Two CSV-based directories.
 - NOTE:** CSV-based directories, directory 1 and directory 2 can now support 2000 contacts in each directory.
- Lightweight Directory Access Protocol (LDAP) Directory.
- Microsoft Exchange contacts (Exchange 2007 SP1 or greater interface supported).
- BroadSoft Xsi Enterprise Directory, Personal Contacts, Enterprise Common Phone List, Group Directory, and Group Common Phone List.

When any of these external Directory sources are configured, the contacts from the respective sources will be loaded into your Directory. From the Directory List, you will be able to search for any external Directory source contacts, dial out to the contacts, copy the contacts to the Local Directory, or simply view the external Directory source contact's details.

Configuring an External Directory Source Using the Phone UI

For details on how to enable/disable the external Directory source, change the default folder labels, and enter credentials, please refer to [Enabling/Disabling Directories and Renaming Labels Using the IP Phone UI](#) and [Entering Usernames/Passwords and Connection Testing Using the IP Phone UI](#).

Copying a Contact in an External Directory Source to the Local Directory IP Phone UI

1. Press the programmed **Directory** key.
2. Use the ▲ and ▼ keys to navigate to the respective Directory source folder and select ► **Enter**.

3. (Optional) Using the dialpad keys input the first letter of the contact's name to initialize the search function.
4. Use the ▲ and ▼ keys to highlight the contact you want to copy.
5. Press the # **Copy** key to copy the contact to your Local Directory.

Callers List

NOTE: Callers List information in this User Guide describes the phone's native Callers List. In some environments, the Callers List key may bring up a Callers List provided by the call manager; therefore, depending on your call manager, the Callers List on your phone may function and behave differently than what is documented in this User Guide. If this is the case, contact your System Administrator for more information regarding your specific Callers List.

The Callers List is a stored log of your incoming calls. The 6905 IP phone stores information for up to 200 incoming calls in the Callers List. Your phone logs the number and name (if available) of the caller, when they last called, and the number of times they tried to reach you.

You can view, scroll, and delete line items in the Callers List from the IP phone UI. You can also directly dial from a displayed line item in the Callers List.

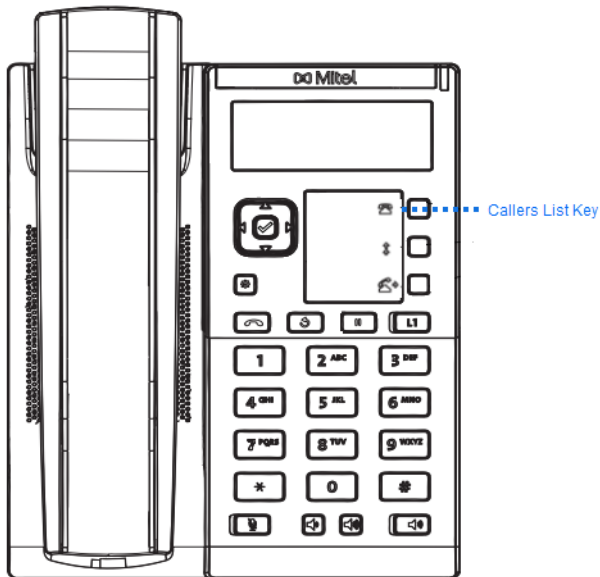

NOTE:



1. When the Callers List is full, the oldest call records are deleted to accommodate the information of new callers.
2. If the telephone number of an incoming or outgoing call matches a number that you have programmed with a name in the Directory, the Callers List display the same name and number.

Icon	Description
	Indicates an unanswered call in the Callers list.

Icon	Description
	Indicates an answered call in the Callers list.

Accessing the Callers List

IP Phone UI

1. Press the programmed **Callers List** key. Press ▲ and ▼ to move through the Callers List. Press ▲ to see the most recent call, or ▼ to see the oldest call on your list.
2. To dial the displayed number just press , lift the handset, or press any **Line** keys.
3. Press the  key to cancel.

Editing Entries in the Callers List

NOTE: The Caller List does not save changes. Editing in the Callers List is generally used if you plan to call the number and need to add a prefix.

In the Callers List, if a keypad key is pressed when a number and/or a name is displayed, the cursor automatically adds the digit at the left side of the number to enable the entry of the prefix.

IP Phone UI

1. Press the programmed **Callers List** key.
2. Press ▲ and ▼ to find the entry you want to edit. Press ▲ to view the most recent call, or to see the oldest call on your list.
3. Press any key on the keypad to begin editing.
4. To move the cursor one digit to the right, press ►. To erase one digit to the left of the cursor, press ▼. To dial the displayed number press , lift the handset, or press any **Line** keys.

Deleting An Entry in the Callers List

1. Press the programmed **Callers List** key.
2. Press ▲ and ▼ to find the item you want to delete.
3. Press the programmed **Delete** key.

DELETE again to
erase this item

4. Press the programmed **Delete** key again at the prompt to erase the item.

Deleting All Entries in the Callers List

IP Phone UI

1. Press the programmed **Callers List** key.
2. Press the programmed **Delete** key.

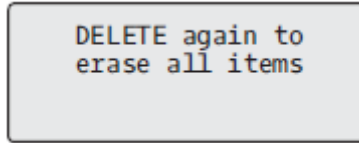

DELETE again to
erase all items

3. Press the programmed **Delete** key again at the prompt to erase all items.

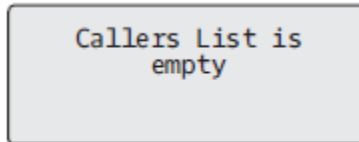

Callers List is
empty

Missed Calls Indicator

The IP phone has a missed calls indicator that increments the number of missed calls to the phone. This feature is accessible from the IP phone UI only.

The number of calls that have not been answered increment on the phone's idle screen as **# Missed Calls**. As the number of unanswered calls increment, the phone numbers associated with the calls are stored in the Callers List. The user can access the Callers List and clear the call from the list. Once the user accesses the Callers List, the **# Missed Calls** on the idle screen is cleared.

Accessing and Clearing Missed Calls

IP Phone UI

1. Press programmed **Callers List** key on the phone.
2. Use the ▲ and ▼ keys to scroll through the line items in the Callers List. The  icon indicates a missed call.
3. To clear a line item from the Callers List, select the line item you want to delete and press the programmed **Delete** key twice. The line item is deleted from the Callers List.

Downloading the Callers List to Your PC

You can download the Callers List to your PC for viewing using the Mitel Web UI. When you download the Callers List, the phone stores the *callerlist.csv* file to your computer in comma-separated value (CSV) format.

You can use any spreadsheet application to open the file for viewing. This file displays the phone number, caller name, and the line that the call came in on.

Download the Callers List

Use the following procedure to download the Callers List to your PC using the Mitel Web UI .

1. Click on **Operation > Directory** .

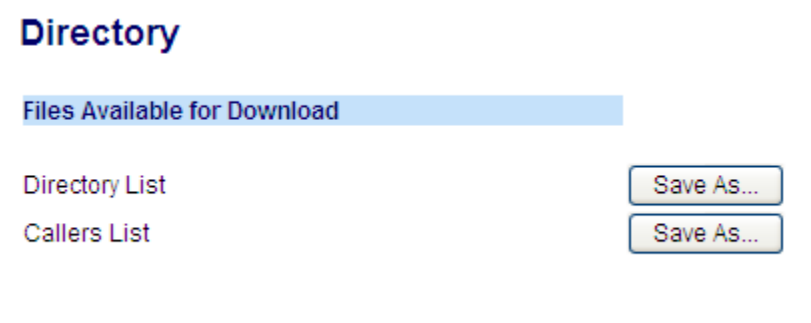

2. In the Callers List field, click on **Save As**.
A download window displays.
3. Click **OK**.
4. Enter the location on your computer where you want to download the Callers List and click **Save**.
The *callerslist.csv* file downloads to your computer.
5. Use a spreadsheet application to open and view the Callers List.

DND and Call Forward

The 6905 has a feature that allows you to configure Do Not Disturb (DND) and Call Forward (CFWD) for multiple accounts on the phone. You can set specific modes for the way you want the phone to handle DND and CFWD. The three modes you can set on the phone for these features are:

- Account
- Phone
- Custom

The following paragraphs describe account-based DND and CFWD:

- DND Configuration
- Call Forward Configuration

DND Configuration

Do Not Disturb (DND) is a feature on the phone that prevents the phone from ringing and receiving incoming calls. When DND is enabled with CFWD, any incoming calls can be call forwarded to voicemail or another number. See [Call Forward Configuration](#) for more information about call forwarding to other numbers.

On the 6905, you can set DND on the phone-side for a specific account or for all accounts on the phone. You can set three modes for DND using the Mitel Web UI at the path, *Basic Settings > Preferences > General > DND Key Mode: Account, Phone (default)* , and *Custom* . DND performs according to the mode you set.

You can then configure a DND key for the phone using the Mitel Web UI at the path, *Operation > Programmable Keys* . You can enable and disable DND by toggling the key or by setting DND for a specific account at the path, *Basic Settings > Account Configuration* . Once you enable DND, DND On displays on the LCD for the applicable account.

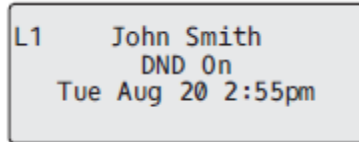

NOTE: If there is only one account configured on the phone, then the mode setting is ignored and the phone behaves as if the mode was set to Phone.

The following describes the key behavior for each DND mode.

- Account: The DND key toggles the account in focus on the IP phone UI, to ON or OFF if DND enabled for that account.
- Phone (default): The DND key toggles all accounts on the phone to ON or OFF.
- Custom: The DND key displays custom screens on the IP phone UI. User can select whether to enable/disable DND per account, enable DND on all accounts, or disable DND on all accounts.
 - If you make changes to the configuration for DND through the IP phone UI, you must refresh the Mitel Web UI screen to see the changes.
 - If DND is enabled for an account, the Message Waiting Indicator (MWI) LED will turn on when the DND-enabled account is in focus.

Configuring a DND Key

To configure a DND key, see the section, [Do Not Disturb \(DND\) Key](#) .

NOTE: If there is no **DND** key configured or if it is removed, DND is disabled on the IP phone.

Configuring DND Using the Mitel Web UI

1. Click on **Basic Settings > Preferences > General**.

Preferences

General

Display DTMF Digits	<input type="checkbox"/> Enabled
Play Call Waiting Tone	<input checked="" type="checkbox"/> Enabled
Stuttered Dial Tone	<input checked="" type="checkbox"/> Enabled
XML Beep Support	<input checked="" type="checkbox"/> Enabled
Status Scroll Delay (seconds)	5
Switch UI Focus To Ringing Line	<input checked="" type="checkbox"/> Enabled
Call Hold Reminder During Active Calls	<input type="checkbox"/> Enabled
Call Hold Reminder	<input type="checkbox"/> Enabled
Call Waiting Tone Period	0
Preferred line	1
Preferred line Timeout (seconds)	0
Goodbye Key Cancels Incoming Call	<input type="checkbox"/> Enabled
Message Waiting Indicator Line	All
DND Key Mode	Phone
Call Forward Key Mode	Account

2. In the **DND Key Mode** field, select a DND mode to use on the phone. Valid values are: Account, Phone (default), Custom. Default is Phone.
 - Account: Sets DND for a specific account. DND key toggles the account in focus on the phone to on or off.
 - Phone (default): Sets DND on for all accounts on the phone. DND key toggles all accounts on the phone to on or off.
 - Custom: Sets the phone to display custom screens after pressing the DND key that list the account(s) on the phone.
3. The user can select a specific account for DND, turn DND on for all accounts, or turn DND off for all accounts.

NOTE:

 - a. If there is only one account configured on the phone, then the mode setting is ignored and the phone behaves as if the mode was set to Phone.
 - b. Using the Mitel Web UI, if you change the **DND Key Mode** to Phone, all accounts synchronize to the current setting of Account 1.
4. Click **Save Settings**. The changes takes affect immediately without a reboot.
5. Click on **Basic Settings > Account Configuration**.

Account Configuration

Account	DND	Call Forward	State	Value	No. Rings
1. John Smith	<input checked="" type="checkbox"/>	All	<input type="checkbox"/>	<input type="text"/>	
		Busy	<input checked="" type="checkbox"/>	4200	
		No Answer	<input type="checkbox"/>	<input type="text"/>	4 <input type="button" value="v"/>
2. J. Smith	<input type="checkbox"/>	All	<input type="checkbox"/>	<input type="text"/>	
		Busy	<input type="checkbox"/>	<input type="text"/>	
		No Answer	<input type="checkbox"/>	<input type="text"/>	4 <input type="button" value="v"/>

6. For each account, enable DND by placing a check mark in the box. Disable DND by unchecking the box.

NOTE:

- If you selected Account or Custom mode in Step 2, you can enable/disable each account or all accounts as applicable. If you selected Phone mode, the first account allows you to change the DND status for all accounts.
- Number and name of accounts that display to this screen are dependent on the number and name of accounts configured on the phone. Only your Administrator can create accounts for your phone. Contact your Administrator for more information.

7. Click **Save Settings**. The changes takes affect immediately without a reboot.

Using DND Modes through the IP Phone UI

After you add a DND key to your phone, you can toggle the DND state using this key on the phone. Use the following procedure to enable/disable DND on the IP phone.

The following procedures assume you have already configured a DND key AND assumes there are two accounts configured on the phone.

NOTE:

- If there is no **DND** key configured or if it is removed, DND is disabled on the IP phone.
- If there is only one account configured on the phone, then the mode setting is ignored and the phone behaves as if the mode was set to Phone.
- Using the Mitel Web UI, if you change the DND key mode to Phone, all accounts synchronize to the current setting of Account 1.

DND in Account Mode IP Phone UI

1. Use the ◀ and ▶ navigation keys to scroll through each account.

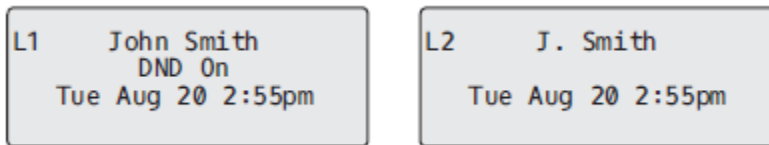

2. With the account in focus on the IP phone UI, press the **DND** key to turn on/off DND for the account.

In the above example, two accounts are configured on the phone. Only account 1 has DND enabled while account 2 has DND disabled.

DND in Phone Mode (Default) IP Phone UI

1. Press the **DND** key to turn on/off DND for all accounts on the phone.
2. Use the ◀ and ▶ navigation keys to scroll through each account.



In the above example, enabling DND for account 1 also enables DND for account 2.

DND in Custom Mode IP Phone UI

1. Press the **DND** key on the phone. The screen displays a list of the accounts on the phone and allows you to enable/disable a specific account or all accounts.
2. Use the ▲ and ▼ navigation keys to scroll through the accounts.

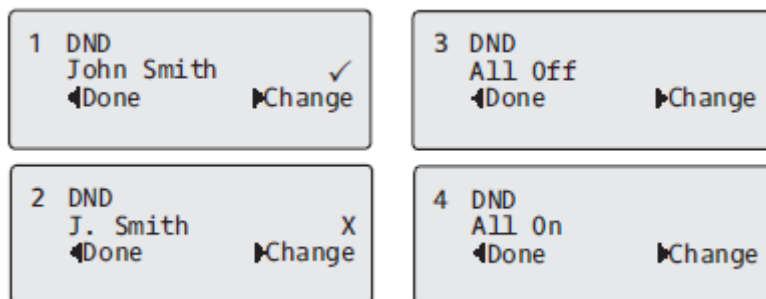

In the above example, account 1 has DND enabled as indicated by a check mark (☑). Account 2 has DND disabled as indicated by an X. Items ◀ and ▶ allow you to disable or enable DND on all accounts, respectively.

3. Use the 4 **Change** key to enable or disable DND for a specific account or to enable/disable DND for all accounts.

After making the change, press 3 **Done** and then # **Confirm** to save the change. Pressing 0 **Cancel** cancels the attempted change.

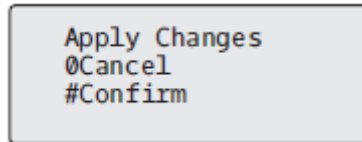

Call Forward Configuration

Call Forward (CFWD) on the IP phone allows incoming calls to be forwarded to another destination.

On the 6905, you can set CFWD on the phone-side for a specific account or for all accounts on the phone. You can set three modes for CFWD using the Mitel Web UI at the path, *Basic Settings > Preferences > General > Call Forward Key Mode: Account* (default), *Phone*, and *Custom*. Call Forward behaves according to the mode you set.

You can configure CFWD using the Mitel Web UI at the path, *Basic Settings > Account Configuration*, or you can configure CFWD using the IP phone UI at the path, *Options > Call Forward*.

Using the Mitel Web UI at the path, *Operation > Programmable Keys*, you can also configure a **CFWD** key on the phone to use as a shortcut for accessing the CFWD menu on the phone.

The following describes the behavior for each CFWD mode:

- **Account (default):** The account mode allows you to configure CFWD on a per account basis. Pressing a configured **CFWD** key applies to the account in focus.
- **Phone:** The Phone mode allows you to set the same CFWD configuration for all accounts (All, Busy, and/or No Answer). When you configure the initial account, the phone applies the configuration to all other accounts. (In the Mitel Web UI, only the account you configured is enabled. All other accounts are grayed out but set to the same configuration.) Using the Mitel Web UI, if you make changes to that initial account, the changes apply to all accounts on the phone.
- **Custom:** The Custom mode allows you to configure CFWD for a specific account or all accounts. You can configure a specific mode (All, Busy, and/or No Answer) for each account independently or all accounts. On the 6905, you can set all accounts to **All On** or **All Off**.

NOTE: If there is only one account configured on the phone, then the mode setting is ignored and the phone behaves as if the mode was set to Phone.

You can enable different CFWD rules/modes independently (for example, you can set different phone numbers for Busy, All, and No Answer modes and then turn them on/off individually).

NOTE:

1. If you make changes to the configuration for CFWD through the IP phone UI, you must refresh the Mitel Web UI screen to see the changes.
2. If CFWD is enabled for an account, the Message Waiting Indicator (MWI) LED will turn on when the CFWD-enabled account is in focus.

Configuring CFWD Using the Mitel Web UI

1. Click on **Basic Settings > Preferences > General**.

Preferences

General

Display DTMF Digits	<input type="checkbox"/> Enabled
Play Call Waiting Tone	<input checked="" type="checkbox"/> Enabled
Stuttered Dial Tone	<input checked="" type="checkbox"/> Enabled
XML Beep Support	<input checked="" type="checkbox"/> Enabled
Status Scroll Delay (seconds)	5
Switch UI Focus To Ringing Line	<input checked="" type="checkbox"/> Enabled
Call Hold Reminder During Active Calls	<input type="checkbox"/> Enabled
Call Hold Reminder	<input type="checkbox"/> Enabled
Call Waiting Tone Period	0
Preferred line	1
Preferred line Timeout (seconds)	0
Goodbye Key Cancels Incoming Call	<input type="checkbox"/> Enabled
Message Waiting Indicator Line	All
DND Key Mode	Phone
Call Forward Key Mode	Account

2. In the **Call Forward Key Mode** field, select a call forward mode to use on the phone.
 - Account (default): The Account mode allows you to configure CFWD on a per account basis. Pressing a configured CFWD key applies to the account in focus.
 - Phone: The Phone mode allows you to set the same CFWD configuration for all accounts (All, Busy, and/or No Answer). When you configure the initial account, the phone applies the configuration to all other accounts. (In the Mitel Web UI, only the account you configured is enabled. All other accounts are grayed out but set to the same configuration.) Using the Mitel Web UI, if you make changes to that initial account, the changes apply to all accounts on the phone.
 - Custom: The Custom mode allows you to configure CFWD for a specific account or all accounts. You can configure a specific state (All, Busy, and/or No Answer) for each account independently or all accounts. On the 6905, you can set all accounts to **All On** or **All Off**.

NOTE: If there is only one account configured on the phone, then the mode setting is ignored and the phone behaves as if the mode was set to Phone.
3. Click **Save Settings**.

The changes take effect immediately without a reboot.
4. Click on **Basic Settings > Account Configuration**.

Account Configuration

Account	DND	Call Forward	State	Value	No. Rings
1. John Smith	<input checked="" type="checkbox"/>	All	<input type="checkbox"/>	<input type="text"/>	
		Busy	<input checked="" type="checkbox"/>	4200	
		No Answer	<input type="checkbox"/>	<input type="text"/>	4 <input type="button" value="v"/>
2. J. Smith	<input type="checkbox"/>	All	<input type="checkbox"/>	<input type="text"/>	
		Busy	<input type="checkbox"/>	<input type="text"/>	
		No Answer	<input type="checkbox"/>	<input type="text"/>	4 <input type="button" value="v"/>

Save Settings

The illustration above shows 2 accounts configured on the phone. Accounts must be set up by your System Administrator.

- For each account, enable the CFWD state by placing a check mark in one or more of the following **State** fields:
 - All
 - Busy
 - No Answer

The All option forwards all incoming calls for this account to the specified phone number regardless of the state of the phone. The phone can be in the Busy or No Answer states, or can be in the idle state. The phone still forwards all calls to the specified number.

The Busy option call forwards incoming calls only if the account is in the busy state. The calls are forwarded to the specified phone number.

The No Answer option call forwards incoming calls only if the account rings but is not answered in the defined number of rings. The call gets forwarded to the specified number.

NOTE: You can use the Busy and No Answer states together using different forwarding phone numbers. If these states are enabled for an account (the All state is disabled), and the phone is in the busy state when a call comes in, the phone can forward the call to the specified phone number (e.g. voicemail). If there is no answer on the phone after the specified number of rings, the phone can forward the call to a different specified number, such as a cell phone number.

- For each account, in the **Value** field, enter the phone number for which you want the incoming calls to forward to if the phone is in the specified state. If using the **Account** mode or **Custom** mode, you can enter different phone numbers for each account.

NOTE:

- a. If you selected Account mode in Step 2, you can enable/disable each account or all accounts as applicable. You can enter different phone number for each enabled state.

If you selected Custom mode, you can enable/disable each account or all accounts as applicable. You can enter different phone numbers for each enabled state.

If you selected Phone mode, all accounts are set to the same CFWD configuration (All, Busy, and/or No Answer) as Account 1 on the phone. (In the Mitel Web UI, only Account 1 is enabled. All other accounts are grayed out but use the same configuration as Account 1).

Using the Mitel Web UI, if you make changes to Account 1, the changes apply to all accounts on the phone. Using the IP phone UI, if you make changes to any other account other than Account 1, the changes also apply to all accounts on the phone. When enabling a CFWD state, you must specify a phone number for the phone to CFWD to. The number you specify applies to all accounts of the same mode.

- b. Number and name of accounts that display to this screen are dependent on the number and name of accounts configured on the phone. The name for the account is specified by your System Administrator. Contact your System Administrator for more information.
7. For the No Answer state, in the **No. Rings** field, enter the number of times that the account rings before forwarding the call to the specified number. Valid values are 1 through 20. Default is 3.
 8. When using the Account mode or Custom mode, you can enter a different number of rings for each account. If you use the Mitel Web UI to change the Call Forward Key Mode to Phone, all accounts synchronize to Account 1.
 9. Click **Save Settings**.

The changes takes affect immediately without a reboot.

Using CFWD through the IP Phone UI

Once CFWD is enabled on your phone, you can access and change the configuration using the IP phone UI or the Mitel Web UI. You can access the CFWD menus by pressing a pre-configured **CFWD** key, or by selecting *Options > Call Forward* from the IP phone UI.

NOTE:

1. If there is no **CFWD** key configured on the phone or it is removed, you can still enable CFWD through the IP phone UI at the path *Options > Call Forward* .
2. If there is only one account configured on the phone, then the mode setting is ignored and the phone behaves as if the mode was set to Phone.
3. Using the Mitel Web UI, if you change the CFWD mode to Phone, all accounts synchronize to the current setting of Account 1.

CFWD in Account Mode IP Phone UI

1. Use the ◀ and ▶ navigation keys to scroll through each account.

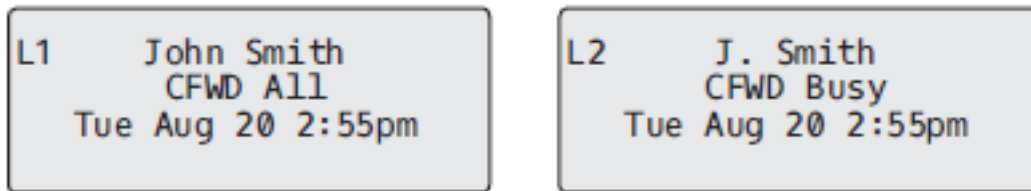

In the above example, account 1 has CFWD All enabled and account 2 has CFWD Busy enabled.

2. Press the programmed **Call Forward** key. The Call Forward Mode screen displays. Use the ▲ and ▼ navigation keys to scroll through each state type.

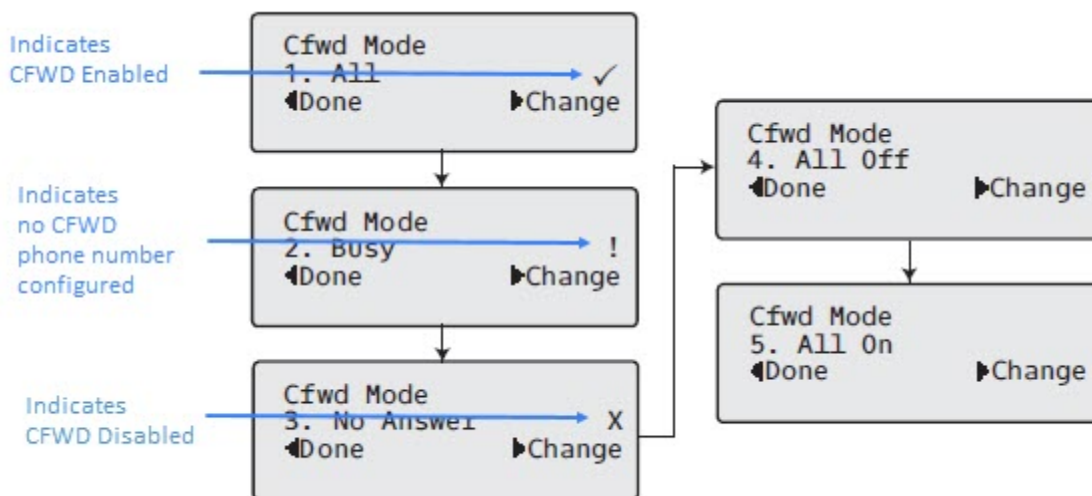

3. In the above example, CFWD All is enabled as indicated by a check mark (☑), CFWD Busy is enabled but no call forward phone number configured as indicated by a !, and CFWD No Answer is disabled, as indicated by an X.

4. Select a state for the account(s) in focus using the ▲ and ▼ navigation keys.

5. You can enable/disable any or all of the following states for an account:

- All: Forwards all incoming calls for the respective account to the specified number.
- Busy: Forwards incoming calls to a specified number if DND has been enabled for that account OR if the account is currently engaged in another call.
- No Answer: Forwards incoming calls to a specified number if the call has not been answered for the specified number of rings.

NOTE: If CFWD All, CFWD Busy, and CFWD No Answer are all enabled (and/or if the account has DND enabled), the CFWD All settings take precedence over CFWD Busy and CFWD No Answer.

You can also use the following keys if required:

- All Off: Disables all CFWD states for the current account in focus
- All On: Enables all CFWD states for the current account in focus

- Press the 4 **Change** navigation key for the state you selected in Step 3. Scroll to the CFWD State screen. This displays the current state of the mode you selected. In the following example, the CFWD All state is ON.

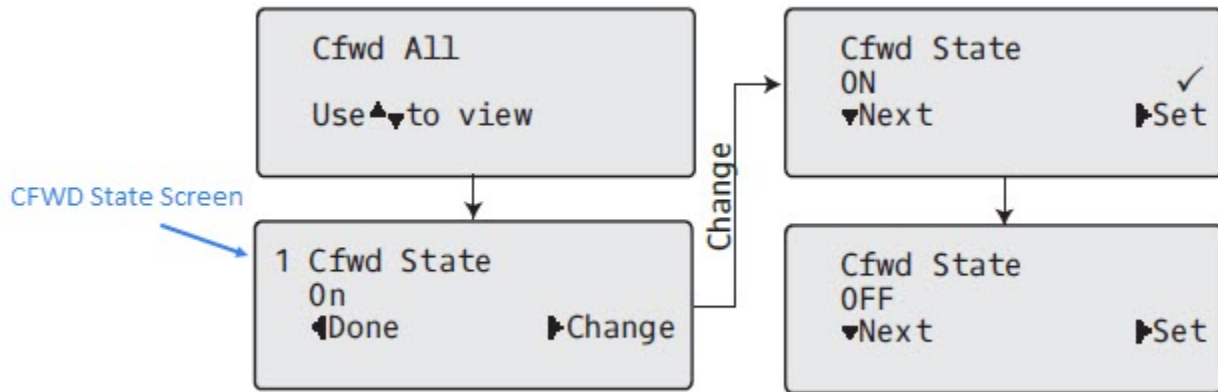

- Press the 4 **Change** navigation key in the CFWD State screen. Press 2 to toggle the state of the CFWD mode ON or OFF. In the example in Step 4, you press 2 to change the option to OFF.
- Press 4 **Set** to save the change.
- In the CFWD State screen, press the 2 navigation keys to scroll to the CFWD Number screen and press 4 **Change**.

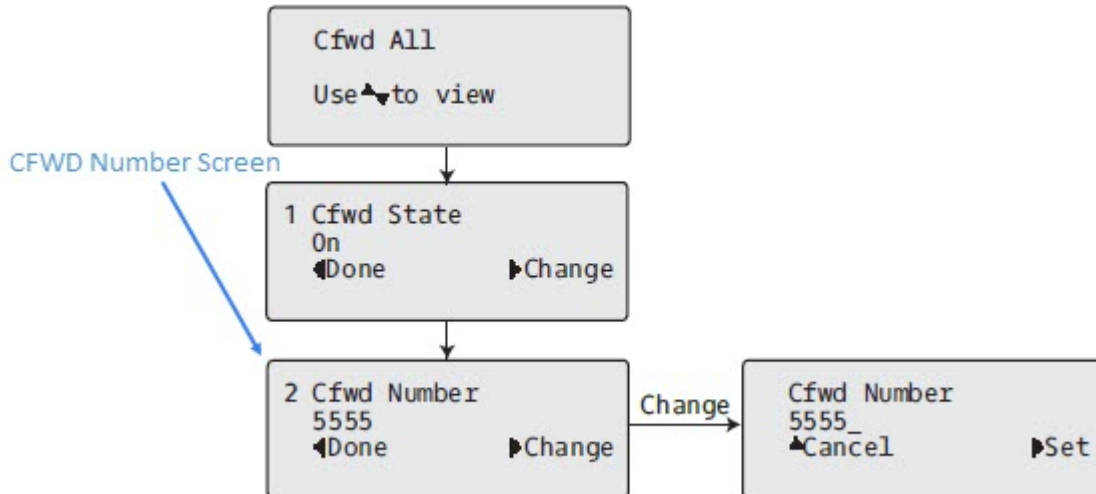

- Enter a phone number to apply to the current state in focus. When the phone is in the state you specified, and a call comes into the phone, it forwards the call to the number you specify.
- Press 4 **Set** to save the change.
- For the **CFWD No Answer** state, In the CFWD Number screen, press the 2 navigation key to scroll to the CFWD No. Rings screen and press 4 **Change**.

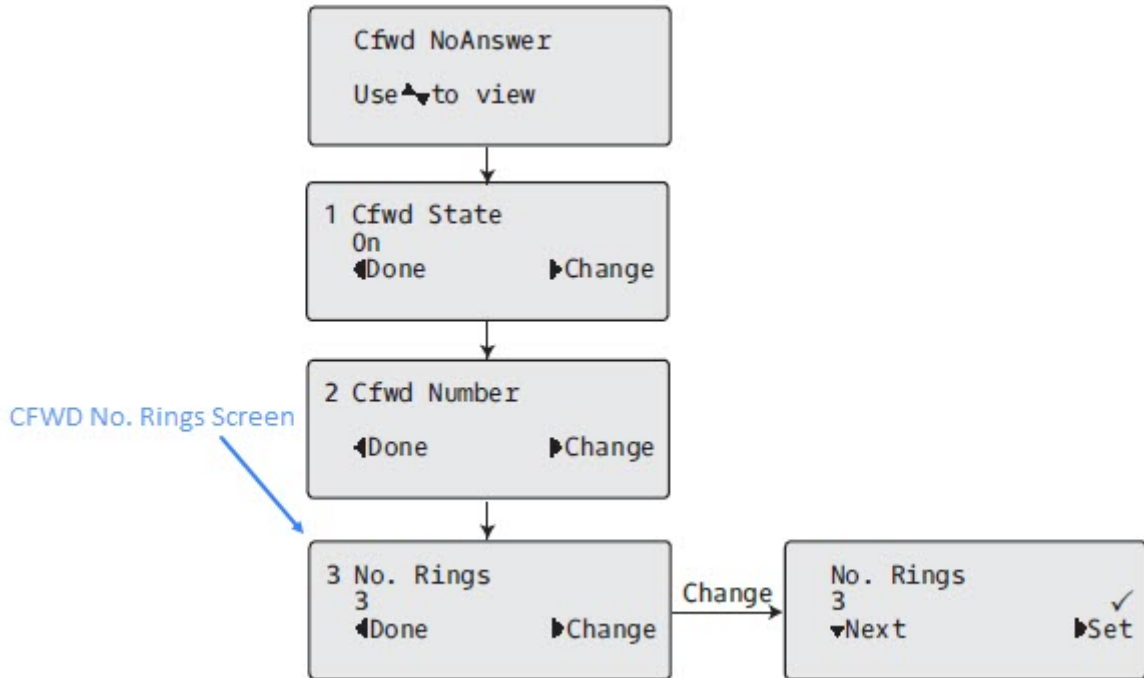

13. Press 2 **Next** to select the number of rings to apply to the phone for call forwarding incoming calls. Valid values are 1 to 20. Default is 3.
14. When the phone receives an incoming call, and call forward is configured on the phone, the phone rings the number of times you specify in the No. Rings screen, and then forwards the call if there is no answer.
15. Press 4 **Set** to save the change.
16. Press 3 **Done** to save all your changes.
17. Each time you press 3 **Done** , the following screen displays.

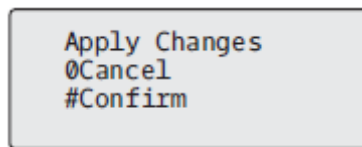

18. Press **# Confirm** to confirm the change(s) each time the Apply Changes screen displays. All changes are saved to the phone.

CFWD in Phone Mode IP Phone UI

1. Use the **◀** and **▶** navigation keys to scroll through each account.



- In the above example, account 1 and account 2 are the accounts configured on the phone. Both accounts have CFWD enabled as indicated by the **CFWD All** message.

NOTE: In Phone mode, when you change the call forward configuration for an account, the change applies to all accounts.

- Press the **Call Forward** key. The Call Forward menu displays. Use the ▲ and ▼ navigation keys to scroll through each state type.

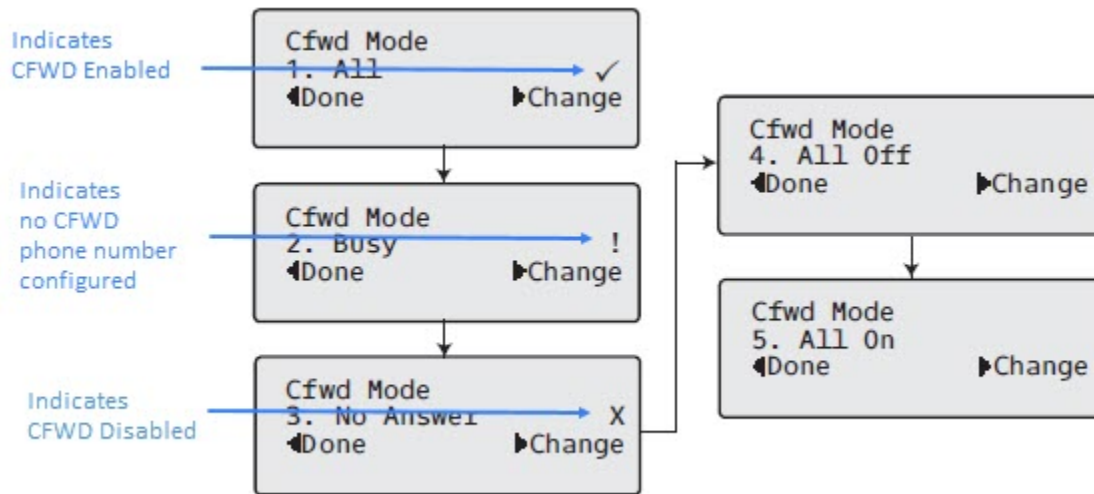

- In the above example, CFWD All is enabled as indicated by a check mark (✓), CFWD Busy is enabled but no call forward phone number configured as indicated by a !, and CFWD No Answer is disabled, as indicated by an X.
- Select a state using the ▲ and ▼ navigation keys.
- You can enable/disable a specific account on the phone with any or all of the following states. However, the configuration you set will apply to all accounts on the phone.
 - All: Forwards all incoming calls for the respective account to the specified number.
 - Busy: Forwards incoming calls to a specified number if DND has been enabled for that account OR if the account is currently engaged in another call.
 - No Answer: Forwards incoming calls to a specified number if the call has not been answered for the specified number of rings.

NOTE: If CFWD All, CFWD Busy, and CFWD No Answer are all enabled (and/or if the account has DND enabled), the CFWD All settings take precedence over CFWD Busy and CFWD No Answer.

You can also use the following keys if required:

- All Off: Disables all CFWD states for the current account in focus
- All On: Enables all CFWD states for the current account in focus

NOTE: In Phone mode, the initial configuration you set for an account applies to all the accounts on the phone.

- Press the **Change** key for the mode you selected in Step 2. Scroll to the CFWD State screen. This screen displays the current state of the mode you selected. In the following example, the CFWD All state is ON.

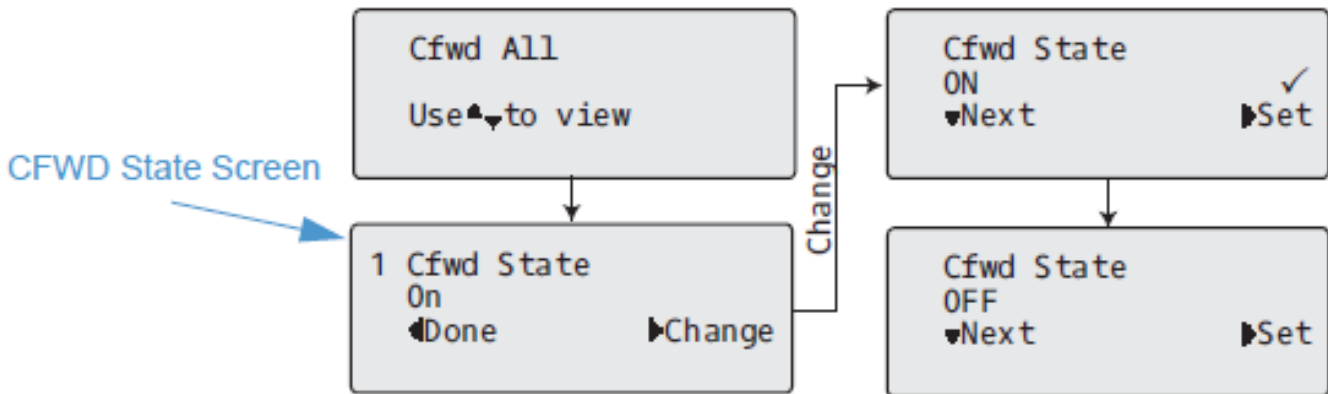

- Press the **Change** key in the CFWD State screen. Press **Next** to toggle the state of the CFWD state ON or OFF. In the example in Step 4, you press **Next** to change the option to **Off**.
- Press the **Set** key to save the change.
- In the CFWD State screen, press the **▲** navigation key to scroll to the CFWD Number screen and press **Change**.

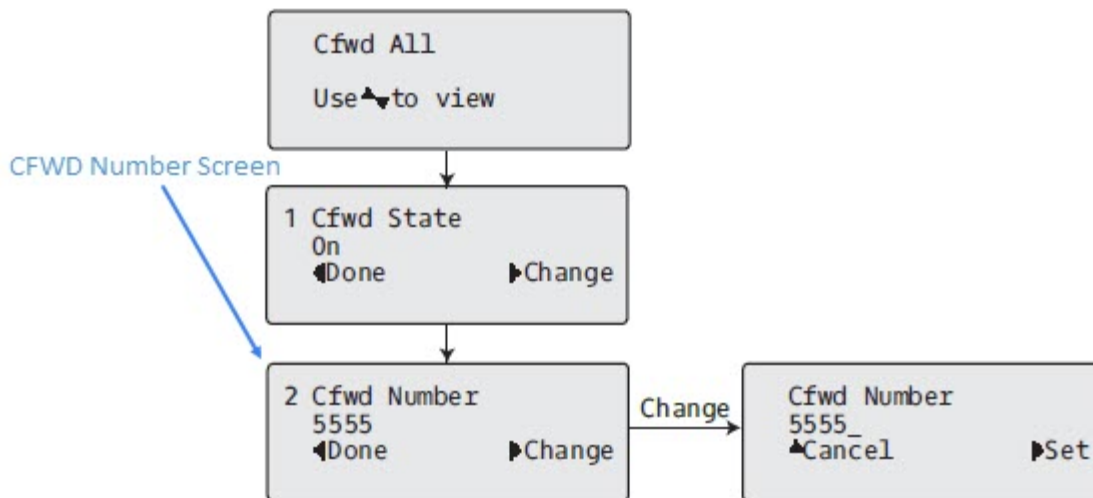

- Enter a phone number to apply to the current state in focus. When the phone is in the state you specified, and a call comes into the phone, it forwards the call to the number you specify.
- Press **Set** to save the change.
- For the **CFWD No Answer** state, in the CFWD Number screen, press the **2** navigation key to scroll to the CFWD No. Rings screen and press **4 Change**.

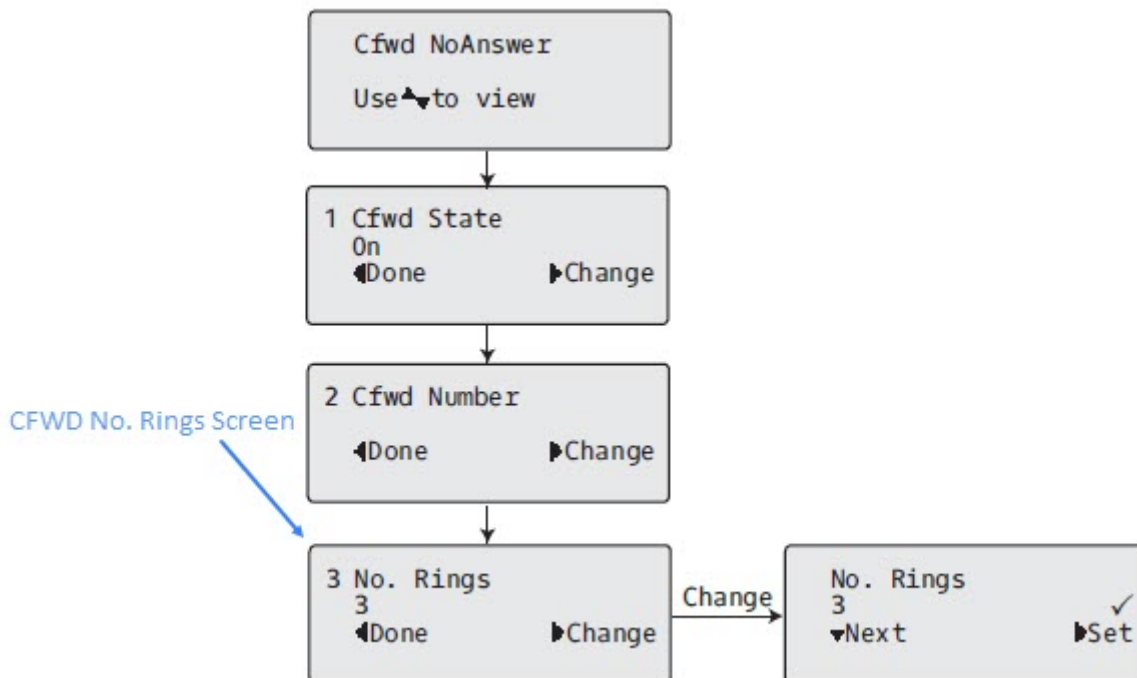

- 14. Press the 2 **Next** key to select the number of rings to apply to the phone for call forwarding incoming calls. Valid values are 1 to 20. Default is 3.
- 15. When the phone receives an incoming call, and call forward is configured on the phone, the phone rings the number of times you specify in the No. Rings screen, and then forwards the call.
- 16. Press **▶ Set** to save the change.
- 17. Press **◀ Done** to save all your changes.
- 18. Each time you press **◀ Done**, the following screen displays.

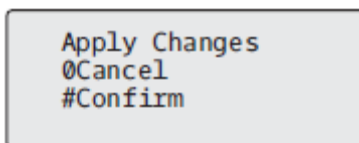

- 19. Press **# Confirm** to confirm the change(s) each time the Apply Changes screen displays. All the same changes are saved to all accounts on the phone.

CFWD in Custom Mode IP Phone UI

- 1. Use the **◀** and **▶** navigation keys to scroll through each account.

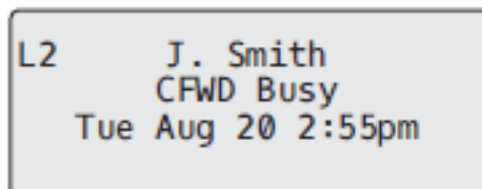
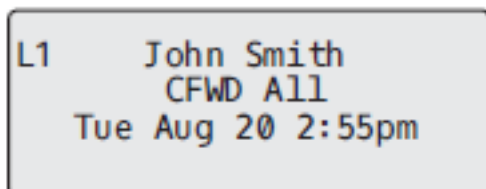

In the above example, account 1 has CFWD All enabled and account 2 has CFWD Busy enabled.

- Press the **Call Forward** key. The Call Forward menu displays. Use the ▲ and ▼ navigation keys to scroll through each state type.

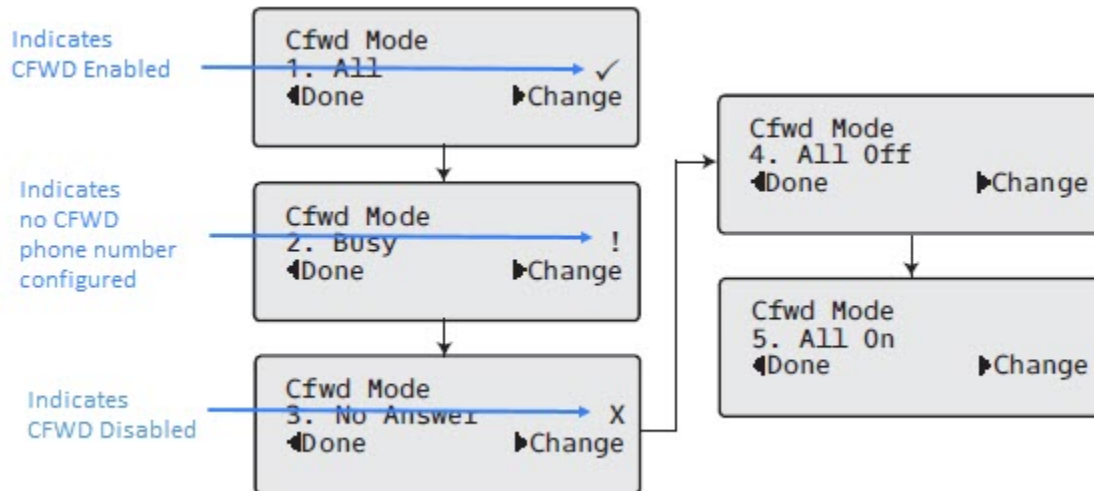

- In the above example, CFWD All is enabled as indicated by a check mark (✓), CFWD Busy is enabled but no call forward phone number configured as indicated by a !, and CFWD No Answer is disabled, as indicated by an X.
- Select a state for the account(s) in focus using the ▲ and ▼ navigation keys.
- You can enable/disable any or all of the following states for a specific account or for all accounts (with individual configurations):
 - All: Forwards all incoming calls for the respective account to the specified number.
 - Busy: Forwards incoming calls to a specified number if DND has been enabled for that account OR if the account is currently engaged in another call.
 - No Answer: Forwards incoming calls to a specified number if the call has not been answered for the specified number of rings.

NOTE: If CFWD All, CFWD Busy, and CFWD No Answer are all enabled (and/or if the account has DND enabled), the CFWD All settings take precedence over CFWD Busy and CFWD No Answer.

You can also use the following keys if required:

- All Off: Disables all CFWD states for the current account in focus
- All On: Enables all CFWD states for the current account in focus

- Press the ► **Change** key for the mode you selected in step 2. Scroll to the CFWD State screen. This displays the current state of the mode you selected. In the following example, the CFWD All state is ON.

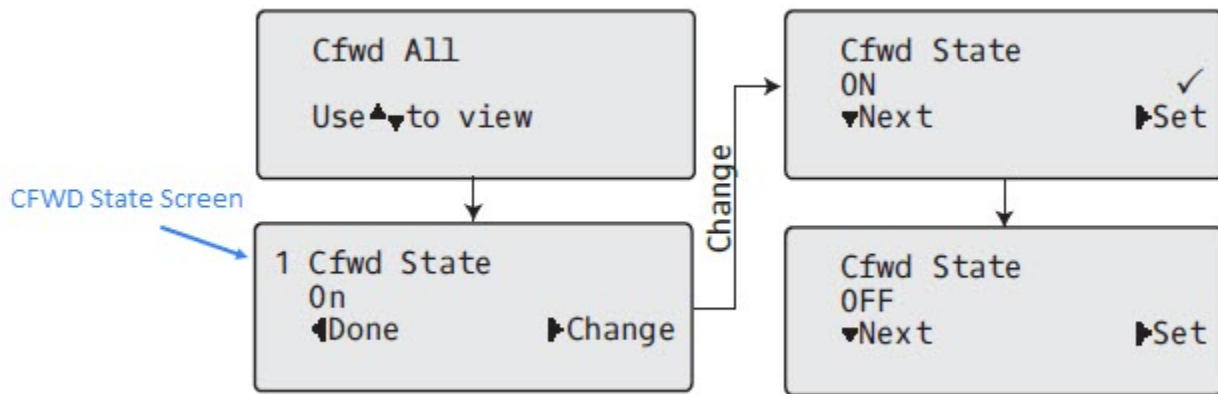

7. Press the ▶ **Change** key in the CFWD State screen. Press ▶ **Next** to toggle the state of the CFWD state ON or OFF. In the example in Step 4, you press ▶ **Next** to change the option to **Off**.
8. Press the **Set** key to save the change.
9. In the CFWD State screen, press the ▶ **navigation** key to scroll to the CFWD Number screen and press ▶ **Change**.

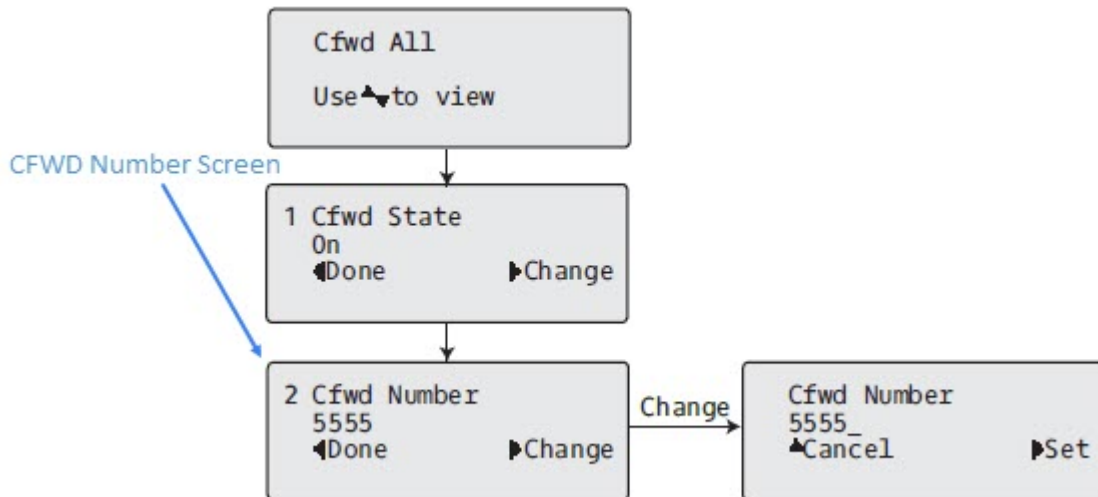

10. Enter a phone number to apply to the current state in focus. When the phone is in the state you specified, and a call comes into the phone, it forwards the call to the number you specify.
11. Press ▶ **Set** to save the change.
12. For the **CFWD No Answer** state, in the CFWD Number screen, press the ▲ navigation key to scroll to the CFWD No. Rings screen and press ▶ **Change**.

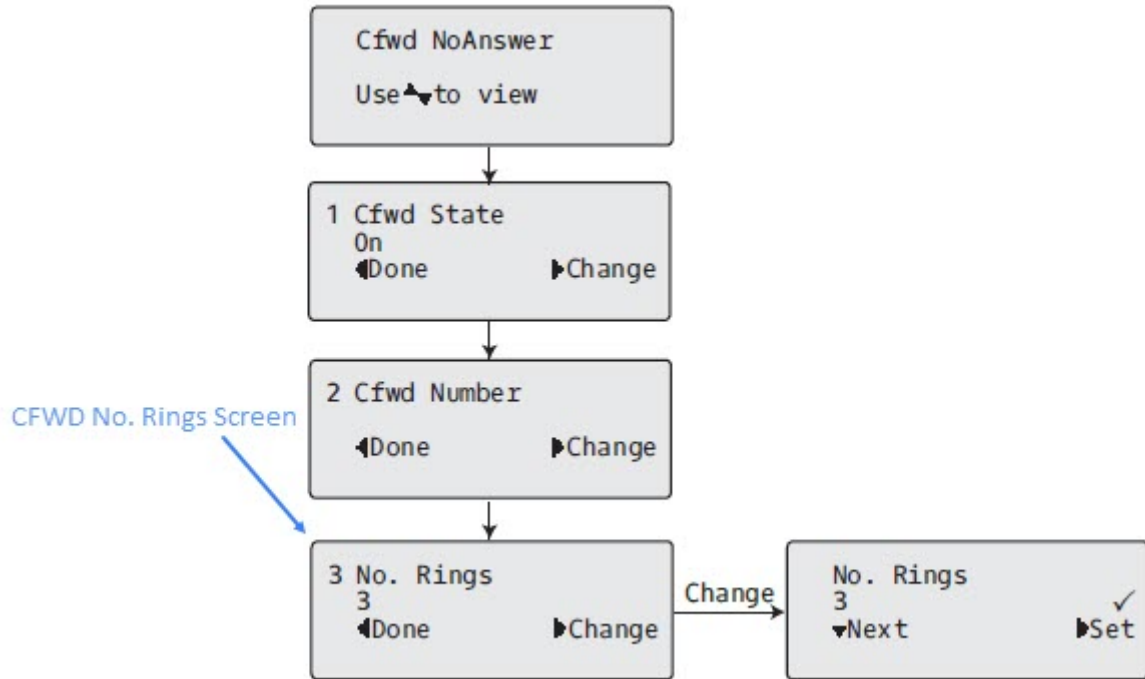

13. Press the ▲ **Next** key to select the number of rings to apply to the phone for call forwarding incoming calls. Valid values are 1 to 20. Default is 3.
14. When the phone receives an incoming call, and call forward is configured on the phone, the phone rings the number of times you specify in the No. Rings screen, and then forwards the call.
15. Press ▶ **Set** to save the change.
16. Press ◀ **Done** to save all your changes.
17. Each time you press 3 **Done** , the following screen displays.

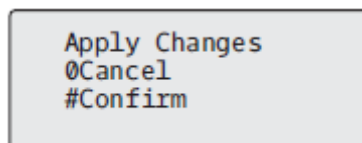

18. Press # **Confirm** to confirm the change(s) each time the Apply Changes screen displays. All changes are saved to the phone for all accounts.

Additional Features

This section describes additional features you can use on the 6905 phone.

Display DTMF Digits

A feature on the IP phones allows users to enable or disable DTMF (dual-tone multi-frequency) digits to display to the IP phone when using the keypad to dial, or when dialing from a programmed key.

DTMF is the signal sent from the phone to the network that you generate when you press the phone's touch keys. This is also known as touch-tone dialing. Each key you press on your phone generates two tones of specific frequencies. One tone is generated from a high-frequency group of tones and the other from a low frequency group.

If you enable the **Display DTMF Digits** parameter, the digits you are dialing from the keypad or from a programmable key display to the IP phone's LCD display. This parameter is disabled by default (no digits display when dialing).

You can enable the **Display DTMF Digits** parameter using the Mitel Web UI.

CONFIGURING DISPLAY OF DTMF DIGITS

MITEL WEB UI

1. Click on **Basic Settings > Preferences > General**.

Preferences

General

Display DTMF Digits	<input type="checkbox"/> Enabled
Play Call Waiting Tone	<input checked="" type="checkbox"/> Enabled
Stuttered Dial Tone	<input checked="" type="checkbox"/> Enabled
XML Beep Support	<input checked="" type="checkbox"/> Enabled
Status Scroll Delay (seconds)	<input type="text" value="5"/>
Switch UI Focus To Ringing Line	<input checked="" type="checkbox"/> Enabled
Call Hold Reminder During Active Calls	<input type="checkbox"/> Enabled
Call Hold Reminder	<input type="checkbox"/> Enabled
Call Waiting Tone Period	<input type="text" value="0"/>
Preferred line	<input type="text" value="1"/> ▼
Preferred line Timeout (seconds)	<input type="text" value="0"/>
Goodbye Key Cancels Incoming Call	<input type="checkbox"/> Enabled
Message Waiting Indicator Line	<input type="text" value="All"/> ▼
DND Key Mode	<input type="text" value="Phone"/> ▼
Call Forward Key Mode	<input type="text" value="Account"/> ▼

2. Enable the **Display DTMF Digits** field by checking the check box.
3. Disable this field by unchecking the box. Default is disabled.
4. Click **Save Settings**.

Play Call Waiting Tone

You can enable or disable the playing of a call waiting tone when you are on an active call and a new call comes into the phone.

You can configure this feature using the Mitel Web UI.

Configuring Call Waiting Tone

Mitel Web UI

1. Click on **Basic Settings > Preferences > General**.

Preferences

General

Display DTMF Digits	<input type="checkbox"/> Enabled
Play Call Waiting Tone	<input checked="" type="checkbox"/> Enabled
Stuttered Dial Tone	<input checked="" type="checkbox"/> Enabled
XML Beep Support	<input checked="" type="checkbox"/> Enabled
Status Scroll Delay (seconds)	5
Switch UI Focus To Ringing Line	<input checked="" type="checkbox"/> Enabled
Call Hold Reminder During Active Calls	<input type="checkbox"/> Enabled
Call Hold Reminder	<input type="checkbox"/> Enabled
Call Waiting Tone Period	0
Preferred line	1
Preferred line Timeout (seconds)	0
Goodbye Key Cancels Incoming Call	<input type="checkbox"/> Enabled
Message Waiting Indicator Line	All
DND Key Mode	Phone
Call Forward Key Mode	Account

2. A call waiting tone is enabled by default. If required, disable the **Play Call Waiting Tone** field by unchecking the check box .
3. Click **Save Settings**.

Stuttered Dial Tone

You can enable or disable the playing of a stuttered dial tone when there is a message waiting on the IP phone.

You can configure this feature using the Mitel Web UI.

Configuring Stuttered Dial Tone

1. Click on **Basic Settings > Preferences > General**.

Preferences

General

Display DTMF Digits	<input type="checkbox"/> Enabled
Play Call Waiting Tone	<input checked="" type="checkbox"/> Enabled
Stuttered Dial Tone	<input checked="" type="checkbox"/> Enabled
XML Beep Support	<input checked="" type="checkbox"/> Enabled
Status Scroll Delay (seconds)	5
Switch UI Focus To Ringing Line	<input checked="" type="checkbox"/> Enabled
Call Hold Reminder During Active Calls	<input type="checkbox"/> Enabled
Call Hold Reminder	<input type="checkbox"/> Enabled
Call Waiting Tone Period	0
Preferred line	1
Preferred line Timeout (seconds)	0
Goodbye Key Cancels Incoming Call	<input type="checkbox"/> Enabled
Message Waiting Indicator Line	All
DND Key Mode	Phone
Call Forward Key Mode	Account

2. Stuttered dial tone is enabled by default. If required, disable the **Stuttered Dial Tone** field by unchecking the check box .
3. Click **Save Settings**.

XML Beep Support

Using the Mitel Web UI, you can enable or disable a beep to be audible when the phone receives an XML application using the **XML Beep Support** field at the path **Basic Settings > Preferences > General**. If you disable this feature, then no beep is heard when the XML application arrives to the phone.

If your System Administrator has set a value for this feature in a custom XML application or in the configuration files, the value you set in the Mitel Web UI overrides the Administrator's setting. Setting and saving the value in the Mitel Web UI applies to the phone immediately.

Configuring XML Beep Support

Mitel Web UI

1. Click on **Basic Settings > Preferences > General**.

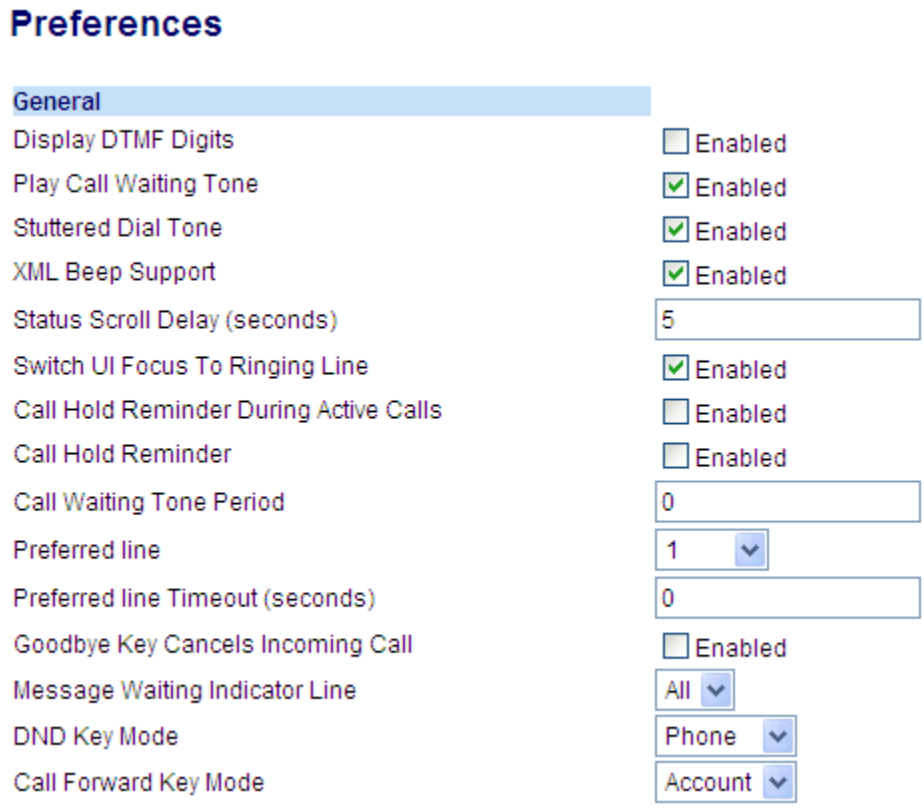

Preferences

General

Display DTMF Digits	<input type="checkbox"/> Enabled
Play Call Waiting Tone	<input checked="" type="checkbox"/> Enabled
Stuttered Dial Tone	<input checked="" type="checkbox"/> Enabled
XML Beep Support	<input checked="" type="checkbox"/> Enabled
Status Scroll Delay (seconds)	<input type="text" value="5"/>
Switch UI Focus To Ringing Line	<input checked="" type="checkbox"/> Enabled
Call Hold Reminder During Active Calls	<input type="checkbox"/> Enabled
Call Hold Reminder	<input type="checkbox"/> Enabled
Call Waiting Tone Period	<input type="text" value="0"/>
Preferred line	<input type="text" value="1"/> ▼
Preferred line Timeout (seconds)	<input type="text" value="0"/>
Goodbye Key Cancels Incoming Call	<input type="checkbox"/> Enabled
Message Waiting Indicator Line	<input type="text" value="All"/> ▼
DND Key Mode	<input type="text" value="Phone"/> ▼
Call Forward Key Mode	<input type="text" value="Account"/> ▼

2. XML Beep Support is enabled by default. If required, disable the **XML Beep Support** field by unchecking the check box .
3. Click **Save Settings**.

Status Scroll Delay

Using the Mitel Web UI, you can specify a scroll delay option that allows you to set the time delay, in seconds, between the scrolling of each status message on the phone. You can specify this setting in the **Status Scroll Delay (seconds)** field at the path **Basic Settings > Preferences > General** . The default time is 5 seconds for each message to display before scrolling to the next message. You can increase or decrease this time as required. Setting and saving the value in the Mitel Web UI applies to the phone immediately.

Configuring Status Scroll Delay

Mitel Web UI

1. Click on **Basic Settings > Preferences > General**.

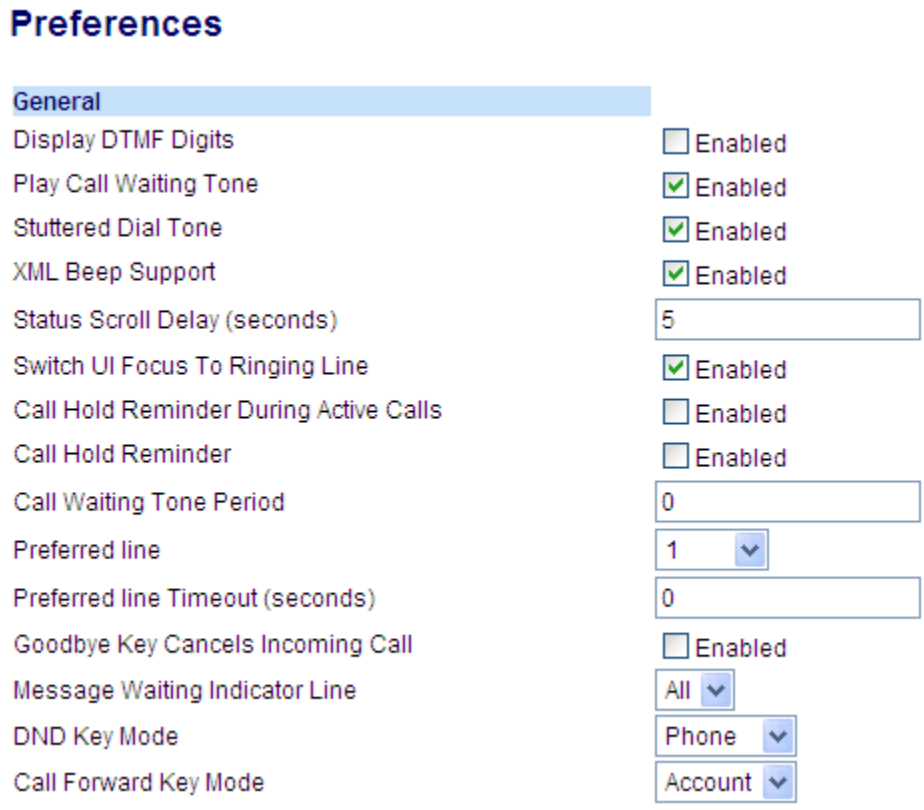

Preferences

General

Display DTMF Digits	<input type="checkbox"/> Enabled
Play Call Waiting Tone	<input checked="" type="checkbox"/> Enabled
Stuttered Dial Tone	<input checked="" type="checkbox"/> Enabled
XML Beep Support	<input checked="" type="checkbox"/> Enabled
Status Scroll Delay (seconds)	<input type="text" value="5"/>
Switch UI Focus To Ringing Line	<input checked="" type="checkbox"/> Enabled
Call Hold Reminder During Active Calls	<input type="checkbox"/> Enabled
Call Hold Reminder	<input type="checkbox"/> Enabled
Call Waiting Tone Period	<input type="text" value="0"/>
Preferred line	<input type="text" value="1"/> ▼
Preferred line Timeout (seconds)	<input type="text" value="0"/>
Goodbye Key Cancels Incoming Call	<input type="checkbox"/> Enabled
Message Waiting Indicator Line	<input type="text" value="All"/> ▼
DND Key Mode	<input type="text" value="Phone"/> ▼
Call Forward Key Mode	<input type="text" value="Account"/> ▼

2. Enter a value in the **Status Scroll Delay (seconds)** field. Valid values are: 1 to 25 seconds. Default is 5.
3. Click **Save Settings**.

Switch UI Focus to Ringing Line

You can configure a feature on the 6905 that controls the behavior of the phone when it receives an incoming call when it is already in a connected call. When a call comes into the phone, and the phone is already on a connected call, the phone switches focus to the ringing line to enable the user to see who is calling them. You can turn off this functionality so that the phone stays focused on the connected call. You can do this using the **Switch Focus to Ringing Line** parameter in the Mitel Web UI.

Configuring Switch Focus to Ringing Line Using the Mitel Web UI

1. Click on **Basic Settings > Preferences > General**.

Preferences

General

Display DTMF Digits	<input type="checkbox"/> Enabled
Play Call Waiting Tone	<input checked="" type="checkbox"/> Enabled
Stuttered Dial Tone	<input checked="" type="checkbox"/> Enabled
XML Beep Support	<input checked="" type="checkbox"/> Enabled
Status Scroll Delay (seconds)	5
Switch UI Focus To Ringing Line	<input checked="" type="checkbox"/> Enabled
Call Hold Reminder During Active Calls	<input type="checkbox"/> Enabled
Call Hold Reminder	<input type="checkbox"/> Enabled
Call Waiting Tone Period	0
Preferred line	1
Preferred line Timeout (seconds)	0
Goodbye Key Cancels Incoming Call	<input type="checkbox"/> Enabled
Message Waiting Indicator Line	All
DND Key Mode	Phone
Call Forward Key Mode	Account

2. The **Switch Focus to Ringing Line** field is enabled by default. To disable this field, uncheck the box.
3. Click **Save Settings**.

Call Hold Reminder During Active Calls

The IP phones allow you to enable or disable the ability for the phone to initiate a continuous reminder tone on the active call when another call is on hold. For example, when this feature is enabled, and the call on Line 1 is on hold, and then the you answer a call on Line 2 and stay on that line, a reminder tone is played in the active audio path on Line 2 to remind you that there is still a call on hold on Line 1.

When this feature is disabled, a ring splash is heard when the active call hangs up and there is still a call on hold.

You can enable or disable this feature using the **Call Hold Reminder During Active Calls** parameter in the Mitel Web UI.

Configuring Call Hold Reminder During Active Calls

Mitel Web UI

1. Click on **Basic Settings > Preferences > General**

Preferences

- General
- Display DTMF Digits Enabled
- Play Call Waiting Tone Enabled
- Stuttered Dial Tone Enabled
- XML Beep Support Enabled
- Status Scroll Delay (seconds)
- Switch UI Focus To Ringing Line Enabled
- Call Hold Reminder During Active Calls Enabled
- Call Hold Reminder Enabled
- Call Waiting Tone Period
- Preferred line ▼
- Preferred line Timeout (seconds)
- Goodbye Key Cancels Incoming Call Enabled
- Message Waiting Indicator Line ▼
- DND Key Mode ▼
- Call Forward Key Mode ▼

2. The **Call Hold Reminder During Active Calls** field is disabled by default. To enable this field, check the box.
3. When this feature is enabled, a reminder tone is heard on the active call when another call is on hold. When disabled, a ring splash is heard when the active call hangs up and there is still a call on hold.
4. Click **Save Settings**.

Call Hold Reminder (on single hold)

On the 6905 IP phone, you can enable or disable a feature that will start the reminder ring splash timer as soon as you put a call on hold (even when no other calls are active on the phone). When enabled, the phone initiates a reminder ring splash periodically for the single call on hold. When disabled, no reminder ring splash is audible.

You can enable or disable this feature using the **Call Hold Reminder** parameter in the Mitel Web UI.

Configuring Call Hold Reminder

Mitel Web UI

1. Click on **Basic Settings > Preferences > General**.

Preferences

General	
Display DTMF Digits	<input type="checkbox"/> Enabled
Play Call Waiting Tone	<input checked="" type="checkbox"/> Enabled
Stuttered Dial Tone	<input checked="" type="checkbox"/> Enabled
XML Beep Support	<input checked="" type="checkbox"/> Enabled
Status Scroll Delay (seconds)	<input type="text" value="5"/>
Switch UI Focus To Ringing Line	<input checked="" type="checkbox"/> Enabled
Call Hold Reminder During Active Calls	<input type="checkbox"/> Enabled
Call Hold Reminder	<input type="checkbox"/> Enabled
Call Waiting Tone Period	<input type="text" value="0"/>
Preferred line	<input type="text" value="1"/> ▼
Preferred line Timeout (seconds)	<input type="text" value="0"/>
Goodbye Key Cancels Incoming Call	<input type="checkbox"/> Enabled
Message Waiting Indicator Line	<input type="text" value="All"/> ▼
DND Key Mode	<input type="text" value="Phone"/> ▼
Call Forward Key Mode	<input type="text" value="Account"/> ▼

2. The **Call Hold Reminder** field is disabled by default. To enable this field, check the box.
3. When this feature is enabled, the reminder ring splash timer starts as soon as you put a call on hold (even when no other calls are active on the phone). The phone initiates a reminder ring splash periodically for the single call on hold. When disabled, no reminder ring splash is audible.
4. Click **Save Settings**.

Call Waiting Tone Period

You can specify a specific time period (in seconds) for the call waiting tone to play at regular intervals on an active call using the parameter **Call Waiting Tone Period**. A value of 0 is the default and plays the call waiting tone only once on the active call. When the incoming caller hangs up, the call waiting tone stops on the existing active call.

You can enable or disable this feature in the Mitel Web UI.

Configuring Call Waiting Tone Period

Mitel Web UI

1. Click on **Basic Settings > Preferences > General**.

Preferences

- General**
- Display DTMF Digits Enabled
- Play Call Waiting Tone Enabled
- Stuttered Dial Tone Enabled
- XML Beep Support Enabled
- Status Scroll Delay (seconds)
- Switch UI Focus To Ringing Line Enabled
- Call Hold Reminder During Active Calls Enabled
- Call Hold Reminder Enabled
- Call Waiting Tone Period
- Preferred line ▼
- Preferred line Timeout (seconds)
- Goodbye Key Cancels Incoming Call Enabled
- Message Waiting Indicator Line ▼
- DND Key Mode ▼
- Call Forward Key Mode ▼

2. In the **Call Waiting Tone Period** field, enter a time period, in seconds, that the call waiting tone will be audible on an active call when another call comes in. Default is 0 seconds. When enabled, the call waiting tone plays at regular intervals for the amount of time set for this parameter. For example, if set to 30 the call waiting tone plays every 30 seconds. When set to 0, the call waiting tone is audible only once on the active call.
3. Click **Save Settings**.

Preferred Line and Preferred Line Timeout

The 6905 has two parameters called preferred line and preferred line timeout. If you enable the preferred line parameter on your phone, after a call ends (incoming or outgoing), the display switches back to the preferred line. Next time you go off-hook to make another call, you pickup on the preferred line. You can enable the **Preferred Line** parameter using the Mitel Web UI at the location, **Basic Settings > Preferences > General**. You can also set a **Preferred Line Timeout** parameter that specifies the number of seconds it takes for the phone to switch back to the preferred line.

The following table provides the behavior of the preferred line focus feature with other features on the phone:

PHONE FEATURE	PREFERRED LINE BEHAVIOR
Last Call Return	The phone switches back to the focused line immediately after the call ends.
Speeddial	The line is already specified when the speed dial is created. The phoneswitches back immediately after the call ends.
Conference	For incoming calls, the phone switches back immediately after the call ends.
Transfer	For incoming or outgoing calls, the current behavior is that the same line used to transfer the call does not change. For incoming calls, the phone switches back immediately after the call transfers.
Park	The phone switches back immediately after the call ends.
Voicemail	The phone switches back immediately after the call ends.
Redial	The phone switches back immediately after the call ends.
Dialing	For incomplete dialing on a non-preferred line, the focus does not change if some digits are entered. If no digits are entered or digits were cleared, the focus changes to preferredline after the time out has passed without activities.
Caller ID	If the Switch UI Focus To Ringing Line parameter is disabled, the User is able to see the Caller ID when the phone switches the focus to the ringing line.
Factory Default	Factory default and recovery mode clears the preferred line and preferred line timeout parameters, and the phone operates in a non-preferred line mode.

NOTE:

1. If you specify a value of 0 for the **Preferred Line** parameter, it disables the preferred line focus feature.
2. If you specify a value of 0 for the **Preferred Line Timeout** parameter, the phone returns the line to the preferred line immediately.

Configuring Preferred Line and Preferred Line Timeout Using the Mitel Web UI

1. Click on **Basic Settings > Preferences > General**.

Preferences

General

Display DTMF Digits	<input type="checkbox"/> Enabled
Play Call Waiting Tone	<input checked="" type="checkbox"/> Enabled
Stuttered Dial Tone	<input checked="" type="checkbox"/> Enabled
XML Beep Support	<input checked="" type="checkbox"/> Enabled
Status Scroll Delay (seconds)	5
Switch UI Focus To Ringing Line	<input checked="" type="checkbox"/> Enabled
Call Hold Reminder During Active Calls	<input type="checkbox"/> Enabled
Call Hold Reminder	<input type="checkbox"/> Enabled
Call Waiting Tone Period	0
Preferred line	1
Preferred line Timeout (seconds)	0
Goodbye Key Cancels Incoming Call	<input type="checkbox"/> Enabled
Message Waiting Indicator Line	All
DND Key Mode	Phone
Call Forward Key Mode	Account



2. In the **Preferred Line** field, select a preferred line to switch focus to after incoming or outgoing calls end on the phone. Default is 1. Valid values are:
 - None (disables the preferred line focus feature)
 - 1 and 2

For example, if you set the preferred line to 2, when a call (incoming or outgoing) ends on the phone (on any line), the phone switches focus back to Line 2.

3. In the **Preferred Line Timeout** field, enter the amount of time, in seconds, that the phone switches back to the preferred line after a call (incoming or outgoing) ends on the phone, or after a duration of inactivity on an active line. Default is 0. Valid values are: 0 to 999
4. Click **Save Settings** .

Goodbye Key Cancels Incoming Calls

The 6905 has a feature that allows you to configure the **Goodbye** key to drop a second incoming call or ignore incoming calls presented to the phone when you are on an active call. The parameter is called **Goodbye Key Cancels Incoming Call** and is configurable through the Mitel Web UI.

If you enable this parameter, which is the default, pressing the  key rejects calls coming into the phone while you are on an active call. When you disable this parameter, pressing the  key hangs up the active call.

If you disable this feature, and the phone receives another call when an active call is already present, the 6905 displays 2 **Ignore** on the LCD. For the 6905, you must use the 2 navigation key to ignore the call.

Configuring Goodbye Key to Cancel Incoming Calls

Mitel Web UI

1. Click on **Basic Settings > Preferences > General**.

Preferences

General	
Display DTMF Digits	<input type="checkbox"/> Enabled
Play Call Waiting Tone	<input checked="" type="checkbox"/> Enabled
Stuttered Dial Tone	<input checked="" type="checkbox"/> Enabled
XML Beep Support	<input checked="" type="checkbox"/> Enabled
Status Scroll Delay (seconds)	<input type="text" value="5"/>
Switch UI Focus To Ringing Line	<input checked="" type="checkbox"/> Enabled
Call Hold Reminder During Active Calls	<input type="checkbox"/> Enabled
Call Hold Reminder	<input type="checkbox"/> Enabled
Call Waiting Tone Period	<input type="text" value="0"/>
Preferred line	<input type="text" value="1"/> ▼
Preferred line Timeout (seconds)	<input type="text" value="0"/>
Goodbye Key Cancels Incoming Call	<input type="checkbox"/> Enabled
Message Waiting Indicator Line	<input type="text" value="All"/> ▼
DND Key Mode	<input type="text" value="Phone"/> ▼
Call Forward Key Mode	<input type="text" value="Account"/> ▼

2. The **Goodbye Key Cancels Incoming Call** field is enabled by default. If required, disable this field by unchecking the check box .
3. Click **Save Settings**.

Message Waiting Indicator

You can configure the Message Waiting Indicator (MWI) to illuminate for a specific line or for all lines. For example, if you configure the MWI LED on Line 2 only, the LED illuminates if a voicemail is pending on Line 2. If you configure the MWI LED for all lines, the LED illuminates if a voicemail is pending on any line on the phone (lines 1 and 2).

You configure the MWI using the Mitel Web UI.

Configuring Message Waiting Indicator

1. Click on **Basic Settings > Preferences > General**.

The screenshot shows the 'Preferences' page with the 'General' tab selected. The following settings are visible:

Setting	Value
Display DTMF Digits	<input type="checkbox"/> Enabled
Play Call Waiting Tone	<input checked="" type="checkbox"/> Enabled
Stuttered Dial Tone	<input checked="" type="checkbox"/> Enabled
XML Beep Support	<input checked="" type="checkbox"/> Enabled
Status Scroll Delay (seconds)	5
Switch UI Focus To Ringing Line	<input checked="" type="checkbox"/> Enabled
Call Hold Reminder During Active Calls	<input type="checkbox"/> Enabled
Call Hold Reminder	<input type="checkbox"/> Enabled
Call Waiting Tone Period	0
Preferred line	1
Preferred line Timeout (seconds)	0
Goodbye Key Cancels Incoming Call	<input type="checkbox"/> Enabled
Message Waiting Indicator Line	All
DND Key Mode	Phone
Call Forward Key Mode	Account

2. The **Message Waiting Indicator Line** field is set to **all** lines by default. If required, change the setting to a specific line by selecting a line from the list. Valid value sAll and lines 1 and 2.
3. Click **Save Settings**.

Incoming Intercom Call Features

By default, the IP phone allows incoming intercom calls to be automatically answered without having to set up an Icom key on your phone. The phone automatically plays a warning tone when it receives an incoming intercom call. It also mutes the microphone. If the intercom call comes into the phone while an active call is already present, the phone puts the active call on hold and answers the intercom call.

You can change the behavior of how the phone handles incoming intercom calls by enabling/disabling specific parameters using the Mitel Web UI.

- Auto Answer
- Microphone Mute
- Play Warning Tone
- Allow Barge In

Auto-Answer/Play Warning Tone

The auto-answer feature on the IP phone allows you to enable or disable automatic answering for an Intercom call. If **Auto-Answer** is enabled, the phone automatically answers an incoming intercom call. If **Play Warning Tone** is also enabled, the phone plays a tone to alert you before answering the intercom call. If **Auto-Answer** is disabled, the phone treats the incoming intercom call as a normal call.

Auto-Answer and **Play Warning Tone** are enabled by default.

NOTE: Your Administrator can set a time period delay before the phone automatically answers. Contact your System Administrator for more information.

Microphone Mute

You can mute or unmute the microphone on the IP phone for intercom calls made by the originating caller. If you want to mute the intercom call, you enable this feature. If you want to unmute (or hear the intercom call), you disable this feature. **Microphone Mute** is enabled by default.

Allow Barge In

You can configure whether or not the IP phone allows an incoming intercom call to interrupt an active call. The **Allow Barge In** parameter controls this feature. When you enable this parameter, which is the default value, an incoming intercom call takes precedence over any active call, by placing the active call on hold and automatically answering the intercom call. When you disable this parameter, and there is an active call, the phone treats an incoming intercom call like a normal call and plays the call warning tone. **Allow Barge In** is enabled by default.

Configuring Incoming Intercom Settings

Mitel Web UI

1. Click on **Basic Settings > Preferences > Incoming Intercom Settings**.

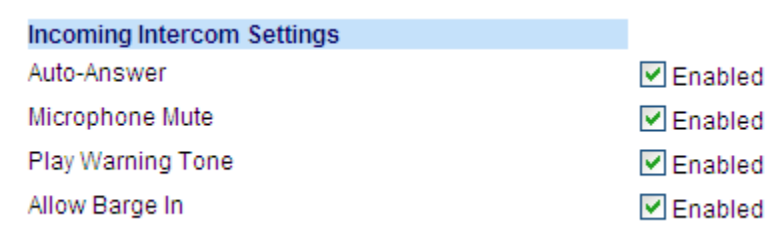

2. The **Auto-Answer** field is enabled by default. The automatic answering feature is turned on for the IP phone for answering Intercom calls. To disable this field, uncheck the box.

NOTE: If the Auto-Answer field is not checked (disabled), the phone treats the incoming intercom call as a normal call.

3. The **Microphone Mute** field is enabled by default. The microphone is muted on the IP phone for Intercom calls made by the originating caller. To disable this field, uncheck the box.
4. The **Play Warning Tone** field is enabled by default. If Auto-Answer is enabled, the phone plays a warning tone when it receives an incoming intercom call. To disable this field, uncheck the box.

5. The **Allow Barge In** field is enabled by default. If Allow Barge In is enabled, the phone puts an active call on hold and answers the incoming Intercom call. To disable this field, uncheck the box.
6. Click **Save Settings**.

Group RTP Paging

You can configure the phone to allow it to receive a Real Time Transport Protocol (RTP) stream from pre-configured multicast address(es) without involving SIP signaling. This is called Group Paging on the IP phones. You can specify up to 5 multicast addresses that the phone listens for on the network. This feature is configurable using the Mitel Web UI only.

The 6905 in the local network listens for RTP on the pre-configured multicast address. The phone displays the Paging message to the phone's LCD. It uses the G711 uLaw CODEC for multicast RTP.

The recipient can drop the incoming page if required. The recipient can also set DND to ignore any incoming pages.

For incoming RTP multicasts, the ringing display is dependent on the setting for the **Allow Barge In** parameter (see [“Allow Barge In”](#)) . If this parameter is disabled, and there is no other call on the phone, then the paging is automatically played through the default audio device.

If there is an existing call on the phone, the call initially displays in the ringing state. The user has the option to accept/ignore the call. If the **Allow Barge In** parameter is enabled, the RTP multicast call barges in, and any existing calls are put on hold.

If an RTP multicast session already exists on the phone, and the phone receives another incoming RTP multicast session, the priority is given to the first multicast session and the second multicast session is ignored. The behavior for the incoming calls in this case is also based on the setting for the **Allow Barge In** parameter. The incoming call is handled as if there were an existing call already on the phone.

Configuring Group RTP Paging

Mitel Web UI

1. Click on **Basic Settings > Preferences > Group Paging RTP Settings** .



2. In the **Paging Listen Addresses** text box, enter the multicast IP address(es) and port number on which the phone listens for incoming multicast RTP packets.
3. Enter the IP address in dotted decimal format (for example, 239.0.1.15:10000,239.0.1.20:15000). You can enter up to 5 listening multicast addresses. If this field is blank, the paging listening capability is disabled on the phone.

NOTE:

- a. Recipient of a paging call can set a global DND to ignore any incoming pages.
- b. For incoming paging, the phone uses the Intercom configuration settings. The incoming page is dependent on the **Allow Barge In** parameter setting and the idling/on call state.

4. Click **Save Settings**.

Shared Call Appearance (SCA) Call Bridging

Shared Call Appearance (SCA) is when incoming calls are presented to multiple phones simultaneously. For example, it is the ability to assign the boss' extension to a key on the secretary's phone. Calls can be transferred between two phones with the same extension key by simply putting the call on hold at one phone and picking it up on the other. Status LEDs light and flash in unison, allowing all people sharing the extension to see the status at a glance.

The phones include an enhanced SCA for the servers that support call bridging and allows two or more SCA users to be connected in a call with a third party. Refer to the following example:

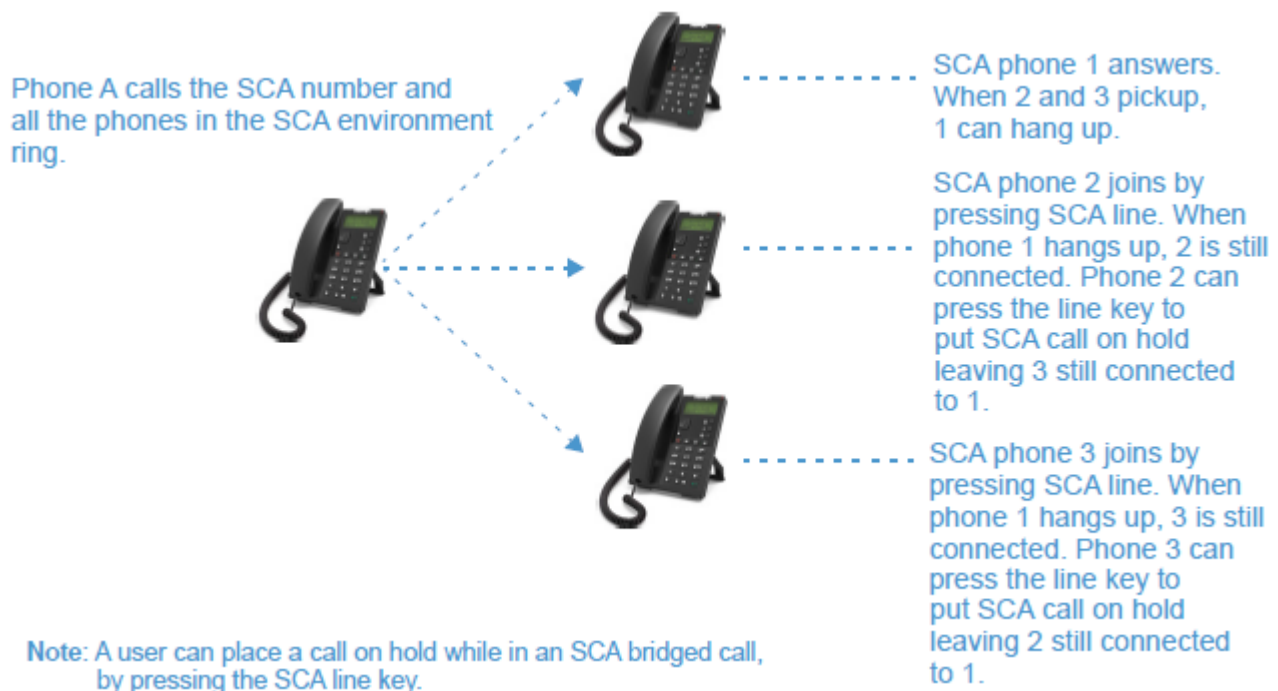

Using the example above, when a call comes into Phone 1, Phone 2 and Phone 3 can pickup the same call by pressing the SCA line key. Phone 2 and 3 display the call they are bridging into on the LCD of the phones. Existing SCA parties in a bridge or one-to-one call hear an audible beep when another party has joined the call.

NOTE: our Administrator must enable/disable the beep on the server-side.

If a phone is configured for SCA bridging and it attempts to join a call, but the account on the server does not have this functionality enabled, an error message displays to the LCD on the phone.

The SCA call bridging feature is disabled by default on all phones. Your Administrator can enable/disable this feature if required. Contact your System Administrator for more information.

Keys States and LED Behavior

There are two call states on the phones that support SCA bridging:

- **Bridge-active** - A bridged call is in progress.
- **Bridge-held** - The 3rd-party (i.e., non-SCA party) in the bridge is on hold.

The following tables provide the key states and LED behavior in an SCA bridge call for users involved in an SCA call and users not involved in the SCA call.

Line Keys and Idle Screens

State	Line LED for Local	Caller ID for Remote	Line LED for Remote	Caller ID for Remote
State	Line LED for Local	Caller ID for Remote	Line LED for Remote	Caller ID for Remote
Idle	Off	N/A	Off	N/A
Seized	Solid Green	None	Solid Red	None
Progressing (outgoing call)	Solid Green	Called Party	Solid Red	None
Alerting (incoming call)	Flashing Red	N/A	N/A	N/A
Active	Solid Green	Far-end	Solid Red	Far-end
Held	Slow Flashing Green	Far-end	Slow Flashing Red	Far-end
Hold private	Slow Flashing Green	Far-end	Solid Red	Far-end
Bridge-active	Solid Green	Far-end	Solid Red	Far-end
Bridge-held	Slow Flashing Green	Far-end	Solid Red	Far-end

Line Key Phone Behavior

State	Local Line Key Pressed	Remote Line Key Pressed
State	Local Line Key Pressed	Remote Line Key Pressed
Idle	N/A	Attempt to seize the line
Seized	Hang up	Ignore
Progressing	Hang up	Ignore
Alerting	Answer	N/A
Active	Hold	Bridge
Held	Retrieve	Bridge
Hold private	Retrieve	Ignore
Bridge-active	Hold	Bridge
Bridge-held	Retrieve	Bridge

Star Codes

All of the main call handling and extension management features using star codes can be set on your phone by your Administrator. Contact your System Administrator for more information.

If these have not been set up, you can dial any star code commands on the 6905 phone the same way you would on a regular telephone.

Other Features

A multitude of other features are available depending on whether or not your System Administrator has configured them for use. Contact your System Administrator for feature availability and usage information.

Troubleshooting Solutions

Why is my display blank?

Ensure that power is being provided to your phone. See the **Connecting to the Network and to Power** section in the **Mitel 6905 Installation Guide** for details.

Why can't I get a dial tone?

Check for any loose connections and that the phone has been installed properly. For installation instructions, please refer to the **Installation and Setup** section in the **Mitel 6905 Installation Guide** provided with your phone.

Why doesn't my phone ring?

Check the ring volume on your phone. It may be turned down or turned off. To adjust the ringer volume setting, press the volume button when the phone is on-hook and idle.

Why is the light not coming on with a new voicemail message?

Your phone system or service provider must provide the visual message waiting service for this function to work. Check with your System Administrator for more information.

Why is my handset not working?

Check to ensure that the handset cord is fully connected to both the phone and handset. See the section **Connecting a Handset** in the **Mitel 6905 Installation Guide** for information.

How do I find the IP address of my phone?

Instructions on where to find the IP address of your phone can be found in this guide in the section, ["Finding Your Phone's IP Address"](#).

Why does my phone display the no service message?

The phone displays the **No Service** message if the SIP settings have not been set up correctly. Contact your System Administrator for more information.

How do I change my user password?

You can change the user password from the IP phone UI or the Mitel Web UI. See [“User Password”](#) for more information.

Why does my phone display bad encrypted config?

The IP phone displays **Bad Encrypted Config** because encrypted configuration files are enabled but the decryption process has failed. Report this error to your System Administrator.

How do I restart the IP phone?

You can restart the phone from the IP phone UI or through the Mitel Web UI. See [“Restarting Your Phone”](#) for more information.

How do I lock my phone?

You can lock your phone to prevent the phone from being used or configured. You can lock the phone using any of the following:

- In the IP phone UI at the path **Options > Phone Lock**. See [“Phone Lock”](#) for more information.
- In the Mitel Web UI at the path **Operations > Phone Lock**. See [“Phone Lock”](#) for more information.
- At a configured Phone Lock key on the phone. For more information about configuring a Lock/Unlock key on your phone, see [“Phone Lock Key”](#).

Limited Warranty

(Not applicable in Australia – see below for Limited Warranty in Australia)

Mitel warrants this product against defects and malfunctions in accordance with Mitel's authorized, written functional specification relating to such products during a one (1) year period from the date of original purchase ("Warranty Period"). If there is a defect or malfunction, Mitel shall, at its option, and as the exclusive remedy, either repair or replace the product at no charge, if returned within the Warranty Period. If replacement parts are used in making repairs, these parts may be refurbished, or may contain refurbished materials. If it is necessary to replace the product, it may be replaced with a refurbished product of the same design and color. If it should become necessary to repair or replace a defective or malfunctioning product under this warranty, the provisions of this warranty shall apply to the repaired or replaced product until the expiration of ninety (90) days from the date of pick up, or the date of shipment to you, of the repaired or replacement product, or until the end of the original Warranty Period, whichever is later. Proof of the original purchase date is to be provided with all products returned for warranty repairs.

Exclusions

Mitel does not warrant its products to be compatible with the equipment of any particular telephone company. This warranty does not extend to damage to products resulting from improper installation or operation, alteration, accident, neglect, abuse, misuse, fire or natural causes such as storms or floods, after the product is in your possession. Mitel will not accept liability for any damages and/or long distance charges, which result from unauthorized and/or unlawful use.

Mitel shall not be liable for any incidental or consequential damages, including, but not limited to, loss, damage or expense directly or indirectly arising from the customer's use of or inability to use this product, either separately or in combination with other equipment. This paragraph, however, shall not apply to consequential damages for injury to the person in the case of products used or bought for use primarily for personal, family or household purposes.

This warranty sets forth the entire liability and obligations of Mitel with respect to breach of warranty, and the warranties set forth or limited herein are the sole warranties and are in lieu of all other warranties, expressed or implied, including warranties or fitness for particular purpose and merchantability.

Warranty Repair Services

Should the product fail during the Warranty Period;

- **In North America**, please call 1-800-574-1611 for further information.
- **Outside North America**, contact your sales representative for return instructions.

You will be responsible for shipping charges, if any. When you return this product for warranty service, you must present proof of purchase.

AFTER WARRANTY SERVICE

Mitel offers ongoing repair and support for this product. This service provides repair or replacement of your Mitel product, at Mitel's option, for a fixed charge. You are responsible for all shipping charges. For further information and shipping instructions:

- **In North America**, contact our service information number: 1-800-574-1611.
- **Outside North America**, contact your sales representative.

NOTE: Repairs to this product may be made only by the manufacturer and its authorized agents, or by others who are legally authorized. This restriction applies during and after the Warranty Period. Unauthorized repair will void the warranty.

Limited Warranty (Australia Only)

The benefits under the Mitel Limited Warranty below are in addition to other rights and remedies to which you may be entitled under a law in relation to the products.

In addition to all rights and remedies to which you may be entitled under the *Competition and Consumer Act 2010* (Commonwealth) and any other relevant legislation, Mitel warrants this product against defects and malfunctions in accordance with Mitel's authorized, written functional specification relating to such products during a one (1) year period from the date of original purchase ("Warranty Period"). If there is a defect or malfunction, Mitel shall, at its option, and as the exclusive remedy under this limited warranty, either repair or replace the product at no charge, if returned within the Warranty Period.

Repair Notice

To the extent that the product contains user-generated data, you should be aware that repair of the goods may result in loss of the data. Goods presented for repair may be replaced by refurbished goods of the same type rather than being repaired. Refurbished parts may be used to repair the goods. If it is necessary to replace the product under this limited warranty, it may be replaced with a refurbished product of the same design and color.

If it should become necessary to repair or replace a defective or malfunctioning product under this warranty, the provisions of this warranty shall apply to the repaired or replaced product until the expiration of ninety (90) days from the date of pick up, or the date of shipment to you, of the repaired or replacement product, or until the end of the original Warranty Period, whichever is later. Proof of the original purchase date is to be provided with all products returned for warranty repairs.

Exclusions

Mitel does not warrant its products to be compatible with the equipment of any particular telephone company. This warranty does not extend to damage to products resulting from improper installation or operation, alteration, accident, neglect, abuse, misuse, fire or natural causes such as storms or floods, after the product is in your possession. Mitel will not accept liability for any damages and/or long distance charges, which result from unauthorized and/or unlawful use.

To the extent permitted by law, Mitel shall not be liable for any incidental damages, including, but not limited to, loss, damage or expense directly or indirectly arising from your use of or inability to use this product, either separately or in combination with other equipment. This paragraph, however, is not intended to have the effect of excluding, restricting or modifying the application of all or any of the provisions of Part 5-4 of Schedule 2 to the Competition and Consumer Act 2010 (**the ACL**), the exercise of a right conferred by such a provision or any liability of Mitel in relation to a failure to comply with a guarantee that applies under Division 1 of Part 3-2 of the ACL to a supply of goods or services.

This express warranty sets forth the entire liability and obligations of Mitel with respect to breach of this express warranty and is in lieu of all other express or implied warranties other than those conferred by a law whose application cannot be excluded, restricted or modified. Our goods come with guarantees that cannot be excluded under the Australian Consumer Law. You are entitled to a replacement or refund for a major failure and for compensation for any other reasonably foreseeable loss or damage. You are also

entitled to have the goods repaired or replaced if the goods fail to be of acceptable quality and the failure does not amount to a major failure.

Warranty Repair Services

Procedure: Should the product fail during the Warranty Period and you wish to make a claim under this express warranty, please contact the Mitel authorized reseller who sold you this product (details as per the invoice) and present proof of purchase. You will be responsible for shipping charges, if any.

Manufacturer: Mitel Networks Corporation

745 Springvale Road

Mulgrave VIC 3170

ABN 16 140 787 195

Phone: +61 3 8562 2700

Limitation of Liability for Products not of a kind ordinarily acquired for personal, domestic or household use or consumption (e.g. goods/services ordinarily supplied for business-use)

1. To the extent permitted by law and subject to clause 1.2 below, the liability of Mitel to you for any non-compliance with a statutory guarantee or loss or damage arising out of or in connection with the supply of goods or services (whether for tort (including negligence), statute, custom, law or on any other basis) is limited to:
 - a. in the case of services:
 - i. the resupply of the services; or
 - ii. the payment of the cost of resupply; and
 - b. in the case of goods:
 - i. the replacement of the goods or the supply of equivalent goods; or
 - ii. the repair of the goods; or
 - iii. the payment of the cost of replacing the goods or of acquiring equivalent goods; or
 - iv. the payment of the cost of having the goods repaired.
2. Clause 1.1 is not intended to have the effect of excluding, restricting or modifying:
 - a. the application of all or any of the provisions of Part 5-4 of Schedule 2 to the Competition and Consumer Act 2010 (the ACL); or
 - b. the exercise of a right conferred by such a provision; or
 - c. any liability of Mitel in relation to a failure to comply with a guarantee that applies under Division 1 of Part 3-2 of the ACL to a supply of goods or services.

After Warranty Service

Mitel offers ongoing repair and support for this product. If you are not otherwise entitled to a remedy for a failure to comply with a guarantee that cannot be excluded under the Australian Consumer Law, this service provides repair or replacement of your Mitel product, at Mitel's option, for a fixed charge. You are responsible for all shipping charges. For further information and shipping instructions contact:

Mitel Networks Corporation

745 Springvale Road

Mulgrave VIC 3170

ABN 16 140 787 195

Phone: +61 3 8562 2700

NOTE: Repairs to this product may be made only by the manufacturer and its authorized agents, or by others who are legally authorized. Unauthorized repair will void this express warranty.

Appendix A - Time Zone Codes

The following table identifies the time zone name and time zone code to use on the IP phone.

TIME ZONE NAME	TIME ZONE CODE
AD-Andorra	CET
AE-Dubai	GST
AG-Antigua	AST
AI-Anguilla	AST
AL-Tirane	CET
AN-Curacao	AST
AR-Buenos Aires	ART
AS-Pago Pago	BST
AT-Vienna	CET
AU-Lord Howe	LHS
AU-Tasmania	EST
AU-Melbourne	EST
AU-Sydney	EST
AU-Broken Hill	CST
AU-Brisbane	EST
AU-Lindeman	EST
AU-Adelaide	CST
AU-Darwin	CST
AU-Perth	WST
AW-Aruba	AST
AZ-Baku	AZT
BA-Sarajevo	EET
BB-Barbados	AST
BE-Brussels	CET
BG-Sofia	EET
BM-Bermuda	AST

TIME ZONE NAME	TIME ZONE CODE
BO-La Paz	BOT
BR-Noronha	FNT
BR-Belem	BRT
BR-Fortaleza	BRT
BR-Recife	BRT
BR-Araguaina	BRS
BR-Maceio	BRT
BR-Sao Paulo	BRS
BR-Cuiaba	AMS
BR-Porto Velho	AMT
BR-Boa Vista	AMT
BR-Manaus	AMT
BR-Eirunepe	ACT
BR-Rio Branco	ACT
BS-Nassau	EST
BY-Minsk	EET
BZ-Belize	CST
CA-Newfoundland	NST
CA-Atlantic	AST
CA-Eastern	EST
CA-Saskatchewan	EST
CA-Central	CST
CA-Mountain	MST
CA-Pacific	PST
CA-Yukon	PST
CH-Zurich	CET
CK-Rarotonga	CKS
CL-Santiago	CLS
CL-Easter	EAS

APPENDIX A - TIME ZONE CODES

TIME ZONE NAME	TIME ZONE CODE
CN-Beijing	CST
CO-Bogota	COS
CR-Costa Rica	CST
CU-Havana	CST
CY-Nicosia	EES
CZ-Prague	CET
DE-Berlin	CET
DK-Copenhagen	CET
DM-Dominica	AST
DO-Santo Domingo	AST
EE-Tallinn	EET
ES-Madrid	CET
ES-Canary	WET
FI-Helsinki	EET
FJ-Fiji	NZT
FK-Stanley	FKS
FO-Faeroe	WET
FR-Paris	CET
GB-London	GMT
GB-Belfast	GMT
GD-Grenada	AST
GE-Tbilisi	GET
GF-Cayenne	GFT
GI-Gibraltar	CET
GP-Guadeloupe	AST
GR-Athens	EET
GS-South Georgia	GST
GT-Guatemala	CST
GU-Guam	CST

APPENDIX A - TIME ZONE CODES

TIME ZONE NAME	TIME ZONE CODE
GY-Guyana	GYT
HK-Hong Kong	HKS
HN-Tegucigalpa	CST
HR-Zagreb	CET
HT-Port-au-Prince	EST
HU-Budapest	CET
IE-Dublin	GMT
IS-Reykjavik	GMT
IT-Rome	CET
JM-Jamaica	EST
JP-Tokyo	JST
KY-Cayman	EST
LC-St Lucia	AST
LI-Vaduz	CET
LT-Vilnius	EET
LU-Luxembourg	CET
LV-Riga	EET
MC-Monaco	CET
MD-Chisinau	EET
MK-Skopje	CET
MQ-Martinique	AST
MS-Montserrat	AST
MT-Malta	CET
MU-Mauritius	MUT
MX-Mexico City	CST
MX-Cancun	CST
MX-Merida	CST
MX-Monterrey	CST
MX-Mazatlan	MST

TIME ZONE NAME	TIME ZONE CODE
MX-Chihuahua	MST
MX-Hermosillo	MST
MX-Tijuana	PST
NI-Managua	CST
NL-Amsterdam	CET
NO-Oslo	CET
NR-Nauru	NRT
NU-Niue	NUT
NZ-Auckland	NZS
NZ-Chatham	CHA
OM-Muscat	GST
PA-Panama	EST
PE-Lima	PES
PL-Warsaw	CET
PR-Puerto Rico	AST
PT-Lisbon	WET
PT-Madeira	WET
PT-Azores	AZO
PY-Asuncion	PYS
RO-Bucharest	EET
RU-Kaliningrad	EET
RU-Moscow	MSK
RU-Samara	SAM
RU-Yekaterinburg	YEK
RU-Omsk	OMS
RU-Novosibirsk	NOV
RU-Krasnoyarsk	KRA
RU-Irkutsk	IRK
RU-Yakutsk	YAK

TIME ZONE NAME	TIME ZONE CODE
RU-Vladivostok	VLA
RU-Sakhalin	SAK
RU-Magadan	MAG
RU-Kamchatka	PET
RU-Anadyr	ANA
SE-Stockholm	CET
SG-Singapore	SGT
SI-Ljubljana	CET
SK-Bratislava	CET
SM-San Marino	CET
SR-Paramaribo	SRT
SV-El Salvador	CST
TR-Istanbul	EET
TT-Port of Spain	AST
TW-Taipei	CST
UA-Kiev	EET
US-Eastern	EST
US-Central	CST
US-Mountain	MST
US-Pacific	PST
US-Alaska	AKS
US-Aleutian	HAS
US-Hawaii	HST
UY-Montevideo	UYS
VA-Vatican	CET
YU-Belgrade	CET

